

Пістунов І.М.

Economic cybernetics : навч. наоч. посіб. /
І.М. Пістунов. – Дніпро : НТУ «ДП», 2022. –
65 с.

The manual discusses the theoretical and practical aspects of analysis, synthesis, modeling and finding optimal solutions for economic systems by means of economic cybernetics.

Examples of the application of theoretical developments are given, methods of calculations with the use of computer applications, such as spreadsheets and mathematical processors are given. Test questions, individual tasks and assignments for course work allow you to better master the material presented and ensure the confident use of cybernetic methods in the real economy.

Designed for students of higher education specialties "Economics".

Рецензенти:

Кострицька С.І., завідувач кафедри іноземних мов НТУ «ДП», проф.

Алексєєв М.О., декан факультету інформаційних технологій, проф.;



CONTENT

PREFACE	3
1. SUBJECT, METHODS AND CONCEPTUAL APPARATUS OF ECONOMIC CYBERNETICS	4
2. MODELING OF SOCIO-ECONOMIC SYSTEMS AS THE MAIN METHOD OF ECONOMIC CYBERNETICS	11
3. ANALYSIS AS A CATEGORY OF KNOWLEDGE AND ITS APPLICATION IN RESEARCH OF SOCIO-ECONOMIC SYSTEMS	17
4. METHODOLOGY AND METHODS OF SYNTHESIS OF MODELS OF SOCIO-ECONOMIC SYSTEMS	26
5. THEORY OF OPTIMAL SYSTEMS AND ITS APPLICATION IN OPTIMIZATION OF MANAGEMENT PROCESSES IN ECONOMY	44



PREFACE

Economic cybernetics, as one of the scientific directions of cybernetics, deals with the application of ideas and methods of cybernetics to economic systems. In a broad sense, economic cybernetics refers to the field of science that emerged at the junction of mathematics and cybernetics with economics, including mathematical programming, operations research, economic-mathematical models, econometrics, and mathematical economics.

Economic cybernetics considers the economy, as well as its structural and functional parts as complex systems in which the processes of regulation and management, which are realized by the movement and transformation of information. Methods of economic cybernetics make it possible to standardize and unify this information, to rationalize the receipt, transmission and processing of economic information, to justify the structure and composition of technical means of its processing.



ALGORITHM OF ECONOMIC CIBERNETICS

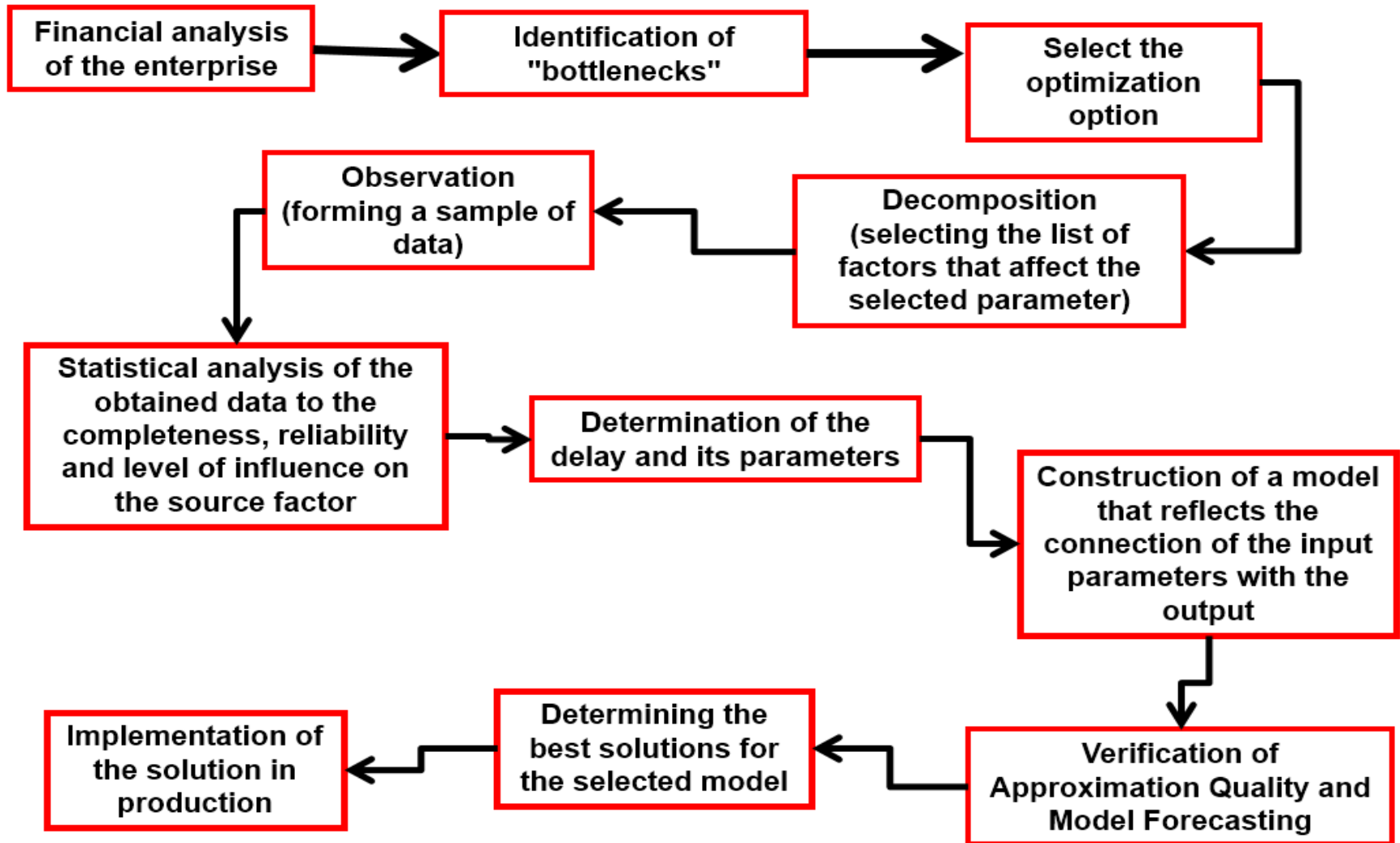

The subject of economic cybernetics is the laws, principles and information processes of management of socio-economic systems.

Methods of economic cybernetics:

Mathematical programming

Operations Research

Econometrics

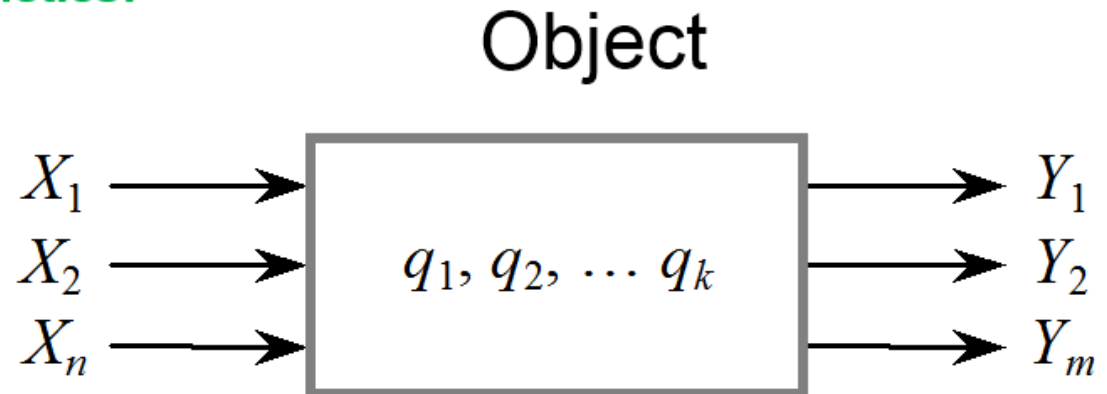

$$y = f(z(t), t), \quad z = g(z(\tau), x(\tau)), \quad \tau \leq t$$

$$\frac{dy}{dt} = f(t, x, z), \quad \frac{dz}{dt} = g(t, x, z)$$

$$z(t_{k+1}) = g(t_k, z(t_k), x(t_k))$$



SYSTEM

Perturbation

Management

\vec{U}

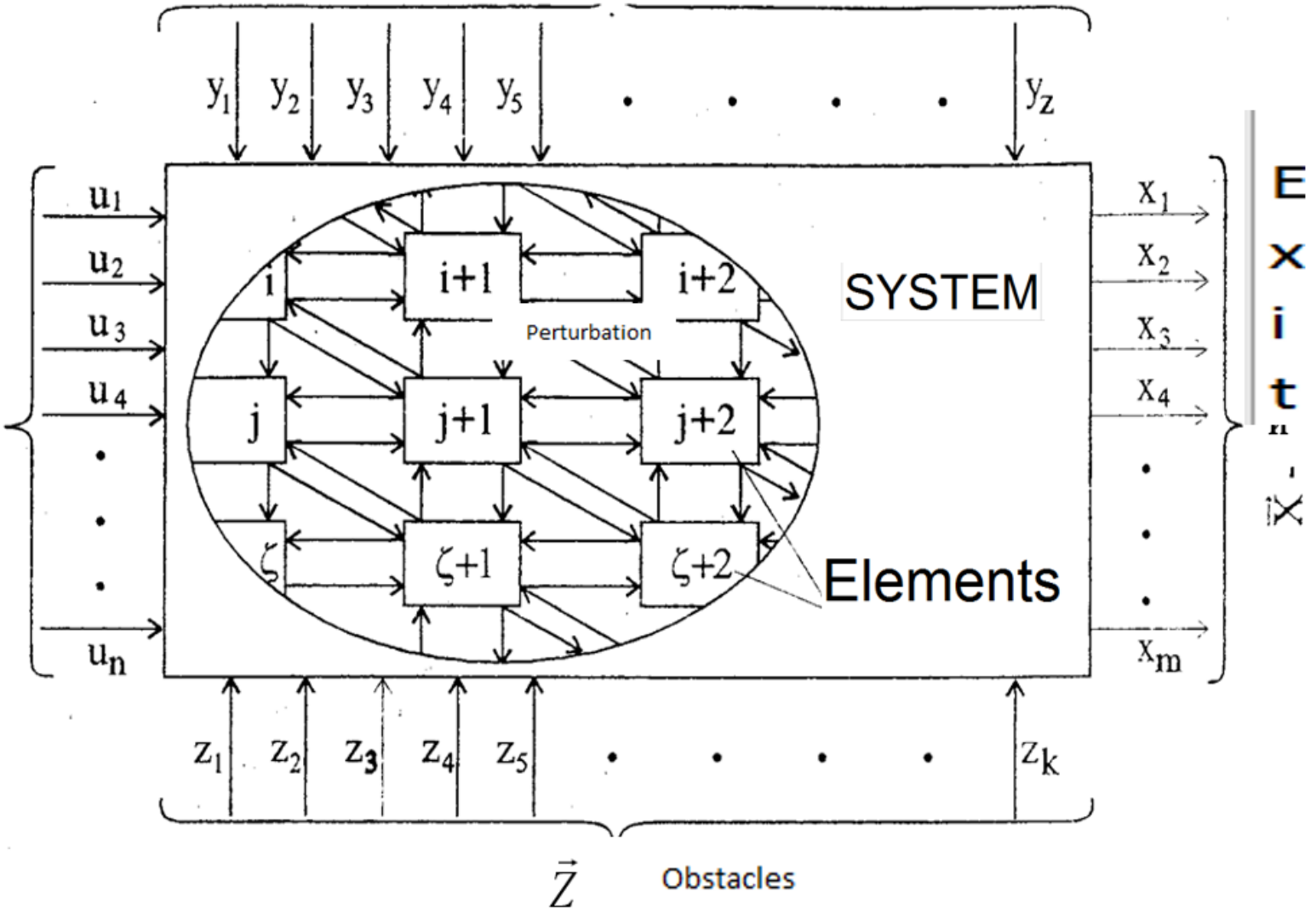

Feedback

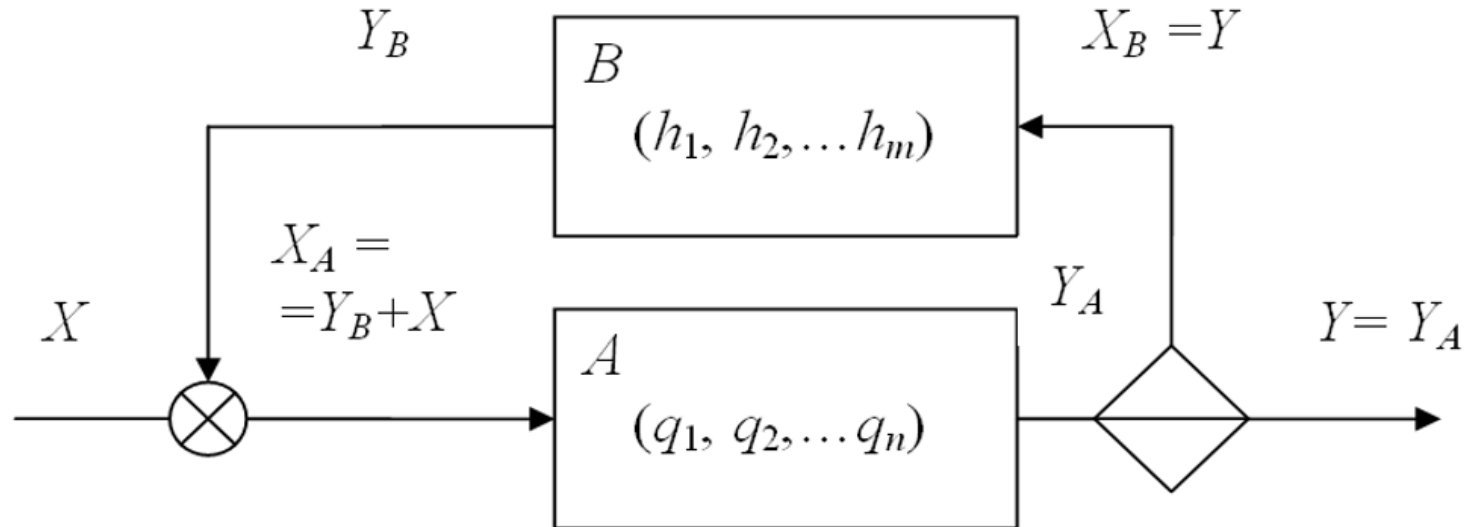

$$Y_A = f(X_A, q_1, q_2, \dots, q_n), \quad Y_B = g(X_B, h_1, h_2, \dots, h_m)$$

$$Y = f(X_A + g(Y, h_1, h_2, \dots, h_m), q_1, q_2, \dots, q_n),$$

$$Y_A = 5 \frac{dX_A}{dt} + 3X_A - 10, \quad Y_B = -8X_B + 4.$$

$$Y = 5 \frac{d[X + (-8Y + 4)]}{dt} + 3[X + (-8Y + 4)] - 10, \quad 40 \frac{dY}{dt} + 25Y = 5 \frac{dX}{dt} + 3X + 2.$$



USE OF THE COMPUTER (MAXIMA PACKAGE) FOR SOLVING DIFFERENTIAL EQUATIONS

Syntax: $\frac{dy}{dx} \rightarrow 'diff(y, x)$ $x^n \rightarrow x^{\wedge} n$ $\sqrt{x} \rightarrow sqrt(x)$

Example: Solve the Cauchy problem for differential equation of the first order

$$x^2 \cdot y' + 3 \cdot y \cdot x = \frac{\sin x}{x}$$

(%i1) `x^2*'diff(y, x) + 3*y*x = sin(x)/x$`

(%i2) `ode2(%, y, x);`

(%o2) $y = \frac{c - \cos(x)}{x^3}$

Initial Condition: $y(\pi) = 0$

For the initial condition, the operator ic1 is assigned.

(%i3) `ic1(%o2, x=%pi, y=0);`

(%o3) $y = -\frac{\cos(x) + 1}{x^3}$



USE OF A COMPUTER (MAXIMA PACKAGE) FOR GRAPHICS BUILDING

Draw a single variable function:

```
(%i1) plot2d (sin(x), [x, -%pi, %pi])$
```

and

```
(%i1) plot2d (sec(x), [x, -2, 2], [y, -20, 20])$
```

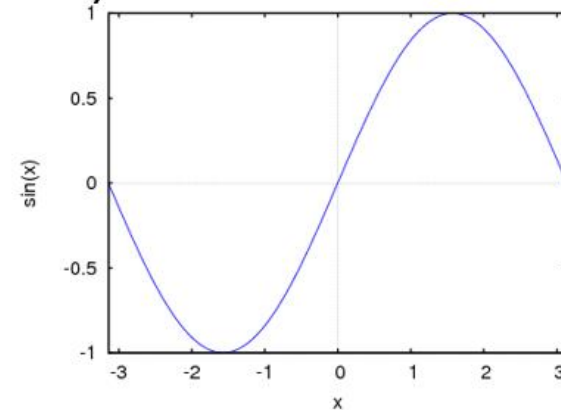
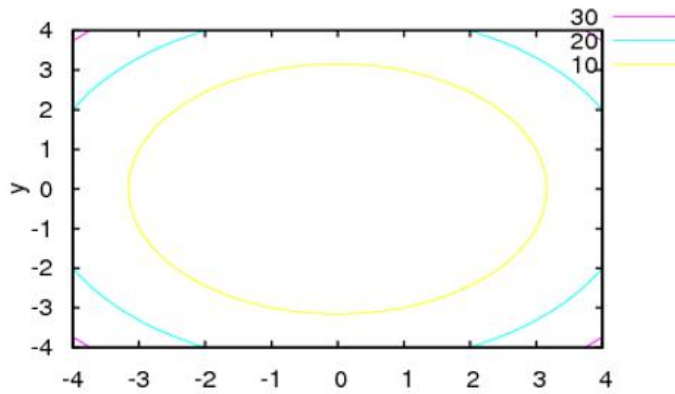

Draw of the function of two variables

```
(%i1) contour_plot (x^2 + y^2, [x, -4, 4],  
[y, -4, 4])$
```

Draw of a three-dimensional image

```
(%i1) plot3d (2^(-u^2 + v^2), [u, -3, 3],  
[v, -2, 2])$
```

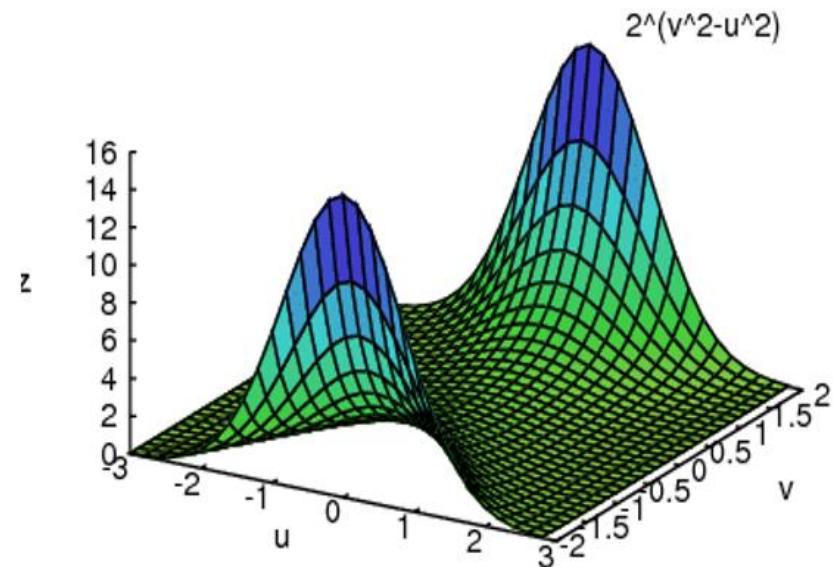

Information

$$H(X) = -\sum_{i=1}^n p_i \log p_i.$$

MAIN LAWS AND PRINCIPLES OF CIBERNETICS

The law of the necessary diversity.

**Principle of decision making based on
selection and transforming information**

The principle of mandatory feedback

Principle of external addition



2. MODELING OF SOCIO-ECONOMIC SYSTEMS AS THE MAIN METHOD OF ECONOMIC CYBERNETICS

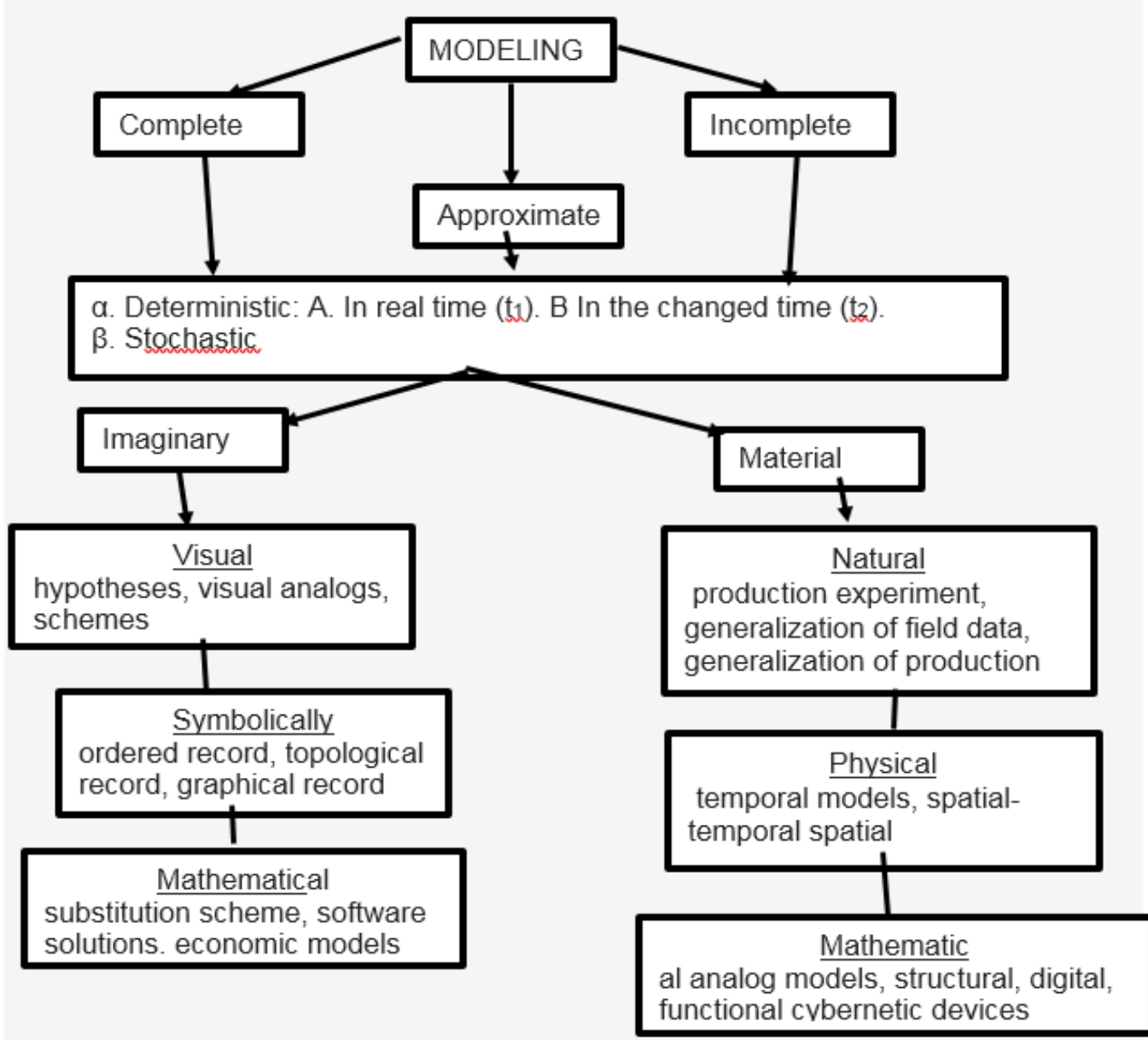

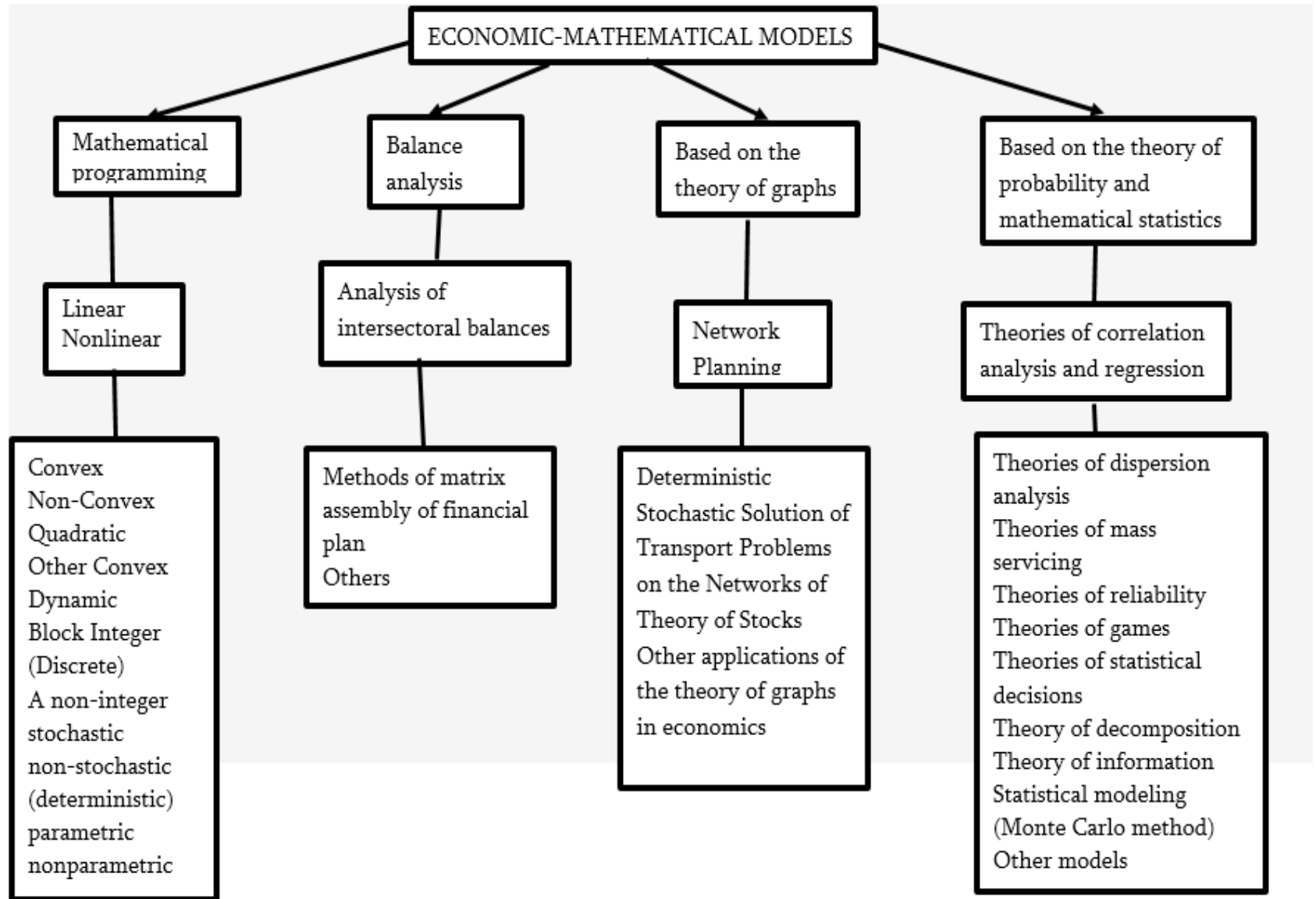

Examples of cybernetic models of socio-economic systems

Interest calculation model

$$r_e = n \left(e^{\frac{r}{n}} - 1 \right) \quad r = n \ln \left(1 + \frac{r_e}{n} \right)$$

$$NPV = \sum_{t=0}^T \frac{In_t - Ot_t}{(1+r_t)^t}$$

Models of financial calculations

$$NPV = \sum_{t=0}^T [In_t - Ot_t](1+r_t)^t$$

Cobb-Douglas Model

$$z = b_0 x^{b_1} y^{b_2}$$

Dynamic models

$$\frac{dx}{dt} = kx(N - x) \quad x = \frac{N}{1 + (\alpha - 1)e^{-Nkt}}$$

Pistunova-Chukhlev's

propensity to bankruptcy of
trade and transport
enterprises of
Dnipropetrovsk region

$$Рейтинг = 0,9 \cdot \frac{\text{ЧДР}^{0,1} \cdot \text{БА}^{0,63} \cdot \text{СПИ}^{0,07}}{\text{КЗ}^{0,73} \cdot 3^{0,07}} \left(\frac{\text{ЧП}(3)}{\text{БА}} + 3 \right)^{0,29}$$

$$\left(\frac{\text{ЧП}(3)}{\text{ЧДР}} + 4 \right)^{0,08},$$



Theory of sets

Operations over sets

Comparison

$$A \subset B :\Leftrightarrow x \in A \Rightarrow x \in B$$

Association

$$A \cup B := \{x | x \in A \vee x \in B\}$$

Crossing

$$A \cap B := \{x | x \in A \wedge x \in B\}$$

Difference

$$A \setminus B := \{x | x \in A \wedge x \notin B\}$$

Symmetric difference

$$A \Delta B \equiv A \dot{-} B := (A \cup B) \setminus (A \cap B) = \{x | (x \in A \wedge x \notin B) \vee (x \notin A \wedge x \in B)\}$$

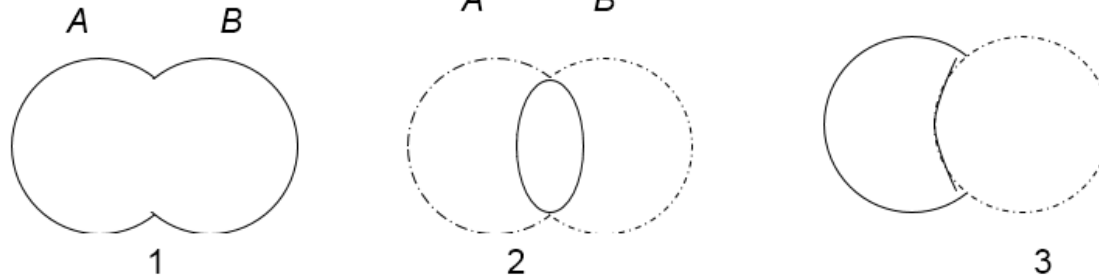

Example of concepts (indicated by solid lines):
the union (1), the intersection (2) and the difference
(3) of the sets A and B.

Tables of special mathematical symbols

Symbol	Name	Value	Example
	Pronunciation		
	The section of mathematics		
\wedge	Conjunction	$A \wedge B$ true if and only if A and B are both true.	$(n > 2) \wedge (n < 4) \Leftrightarrow (n = 3)$ if n is a natural number.
	«and»		
	Mathematical logic		
\vee	Disjunction	$A \vee B$ true, if at least one of the conditions A and B is true.	$(n \leq 2) \vee (n \geq 4) \Leftrightarrow n \neq 3$ if n is a natural number.
	«or»		
	Mathematical logic		
\neg	Denial	$\neg A$ true if and only if A is false.	$\neg(A \wedge B) \Leftrightarrow (\neg A) \vee (\neg B)$
	"not"		
	Mathematical logic		
\forall	Quantum of universality	$\forall x, P(x)$ denotes "P (x) true for all x".	$\forall n \in \mathbb{N}, n^2 \geq n$
	"For Any", "For All"		
	Mathematical logic		
\in	Affiliation / not belonging to the plural	$a \in S$ means "a is an element of the set S"	$2 \in \mathbb{N}$
	"Belongs", "c" does not belong	$a \notin S$ means "a is <u>an</u> not element of the set S"	
	Theory of sets		



\subseteq	Subset	$A \subseteq B$ means "every element of A is also an element of B". $A \subset B$ usually means the same as that $A \subseteq B$. However, some authors use to indicate rigorous inclusion (i.e. \subsetneq).	$(A \cap B) \subseteq A$
	"Is a subset", "included in"		
	Theory of sets		
\cup	Association	$A \cup B$ means a plurality of elements belonging to A or B (or both at once).	$A \subseteq B \Leftrightarrow A \cup B = B$
	"Association. and. ", "., united with. "		
	Theory of sets		
\cap	Crossing	$A \cap B$ means a plurality of elements belonging to both A and B.	$\{x \in \mathbb{R} \mid x^2 = 1\} \cap \mathbb{N} = \{1\}$
	"Crossing. and. ", "., Crossed with. "		
	Theory of sets		
\mathbb{N}	Natural numbers	\mathbb{N} means plural $\{1, 2, 3, \dots\}$ or $\{0, 1, 2, 3, \dots\}$ (depending on the situation).	$\{ a \mid a \in \mathbb{Z}\} = \mathbb{N}$
	«En»		
	Numbers		
\mathbb{Z}	Whole numbers	\mathbb{Z} means plural $\{\dots, -3, -2, -1, 0, 1, 2, 3, \dots\}$	$\{a, -a \mid a \in \mathbb{N}\} = \mathbb{Z}$
	«Zed»		
	Numbers		
\mathbb{Q}	Rational numbers	\mathbb{Q} means plural $\left\{ \frac{p}{q} \mid p \in \mathbb{Z} \wedge q \in \mathbb{Z} \wedge q \neq 0 \right\}$	$3,14 \in \mathbb{Q}$
	«Qu»		
	Numbers		



3. ANALYSIS AS A CATEGORY OF KNOWLEDGE AND ITS APPLICATION IN RESEARCH OF SOCIO-ECONOMIC SYSTEMS

An example of the format of the observation table by factors socio-economic system

Time or date of observation	Incoming factors				Output factors			
	X_1	X_2	...	X_a	Y_1	Y_2	...	Y_m

Statistical

$$M_X = \frac{1}{N} \sum_{i=1}^N X_i$$

$$D_X = \frac{1}{N-1} \sum_{i=1}^N X_i^2 - M_X^2$$

$$\sigma_X = \sqrt{D_X}$$

$$\varepsilon_m = \ddot{\sigma}_x \Phi^{-1}(\beta)$$

$$\varepsilon_D = \ddot{D}_x \Phi^{-1}(\beta) \sqrt{\frac{0,8N+1,2}{N(N-1)}}$$

$$\ddot{\sigma}_m = \sqrt{\frac{D_X}{N}}$$

$$\text{var}(X) = \frac{\ddot{D}(x)}{\ddot{M}(X)}$$

$$K \text{var}(X) = \frac{\ddot{\sigma}(x)}{\ddot{M}(X)}$$



Dispersion analysis

$$r_{xy} = \frac{\sum (x_i - \bar{x}) \cdot (y_i - \bar{y})}{\sqrt{\sum (x_i - \bar{x})^2 \cdot \sum (y_i - \bar{y})^2}}$$

$$z = \frac{1}{2} \ln \frac{1+r}{1-r},$$

$$z' - t_{\gamma} \sqrt{\frac{1}{n-1-3}} \leq z \leq z' + t_{\gamma} \sqrt{\frac{1}{n-1-3}}$$

Analysis of expert conclusions

According to
Spearman

$$\rho = 1 - \frac{6 \sum d_i^2}{n^3 - n}$$

Behind Kendal

$$W = \frac{12 \sum_{i=1}^m \left(\sum_{j=1}^d \rho_{ij} - \frac{d(m+1)}{2} \right)^2}{d^2 (m^3 - m)}$$



Late analysis

Types of inertial processes in socio-economic systems

$$T = \frac{1}{\lambda} \ln \frac{y^0}{\varepsilon}$$

$$\lambda = \frac{1}{T}$$

$$\varepsilon = \frac{y^0}{e} \simeq 0,379y^0$$

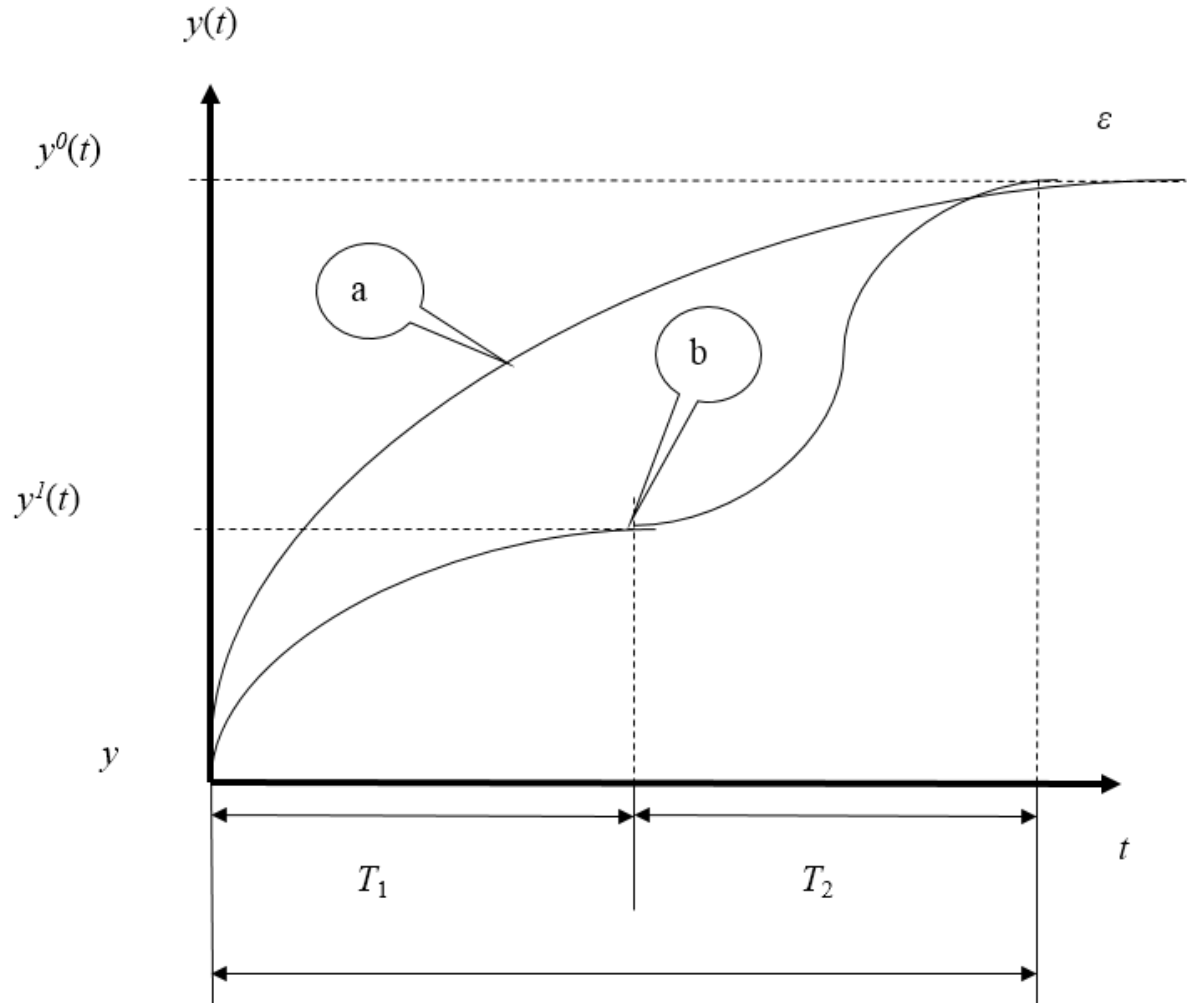
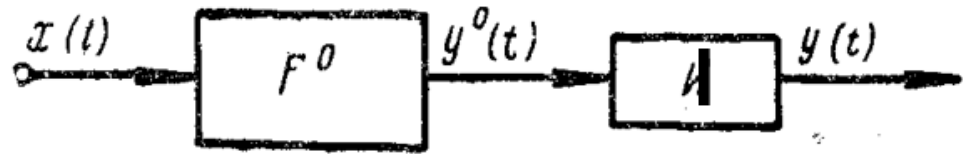

Spectral analysis

The Fourier series - in mathematics - is a way to represent an arbitrary complex function with a simpler sum. In the general case, the number of such functions can be infinite, with the more such functions are taken into account in the calculation, the higher the final accuracy of the representation of this function becomes. In most cases trigonometric functions of sinus and cosine are used as the simplest. In this case, the Fourier series is called trigonometric, and the calculation of such a series is often called a harmonic expansion.



A Fourier trigonometric series is called a series of form

$$y = \frac{a_0}{2} + \sum_{n=1}^{\infty} [a_n \cos(nx) + b_n \sin(nx)]$$

Stain numbers a_0, a_n, b_n ($n \in \mathbb{N}$) called coefficients trigonometric series and are like

$$a_n = \frac{1}{\pi} \int_{-\pi}^{\pi} f(x) \cos(nx) dx, \quad b_n = \frac{1}{\pi} \int_{-\pi}^{\pi} f(x) \sin(nx) dx.$$

Convergence of the Fourier series

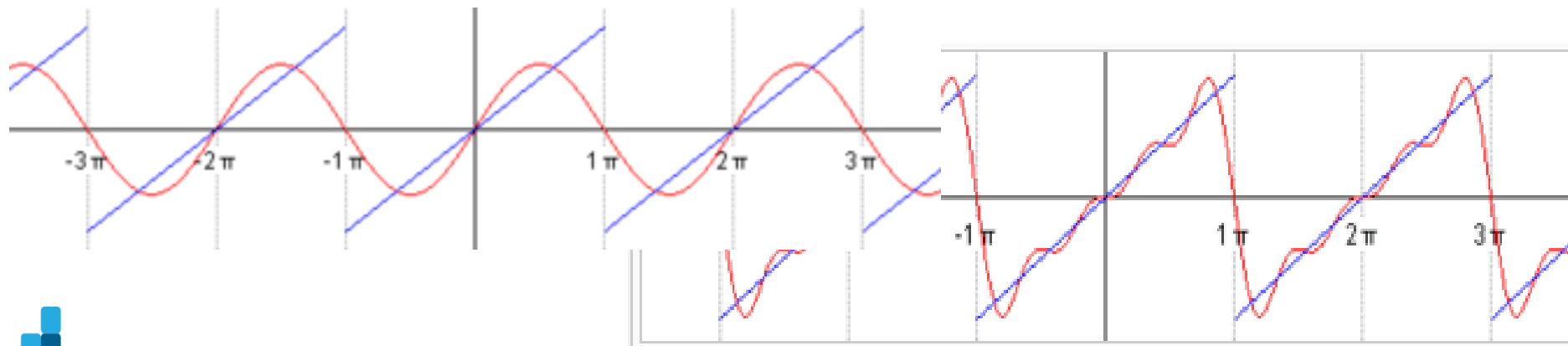

CONSTRUCTION OF THE AMPLITUDE-FREQUENCY CHARACTERISTICS OF PROCESS BY STATISTICA PACKET

Data: Sunspot*...	
Wolfer's sunspot data	
1	SPOTS
1749	809
1750	834
1751	477
1752	478
1753	307
1754	122
1755	96
1756	102
1757	324
1758	476
1759	540
1760	629
1761	859
1762	612
1763	451
1764	364
1765	209
1766	114

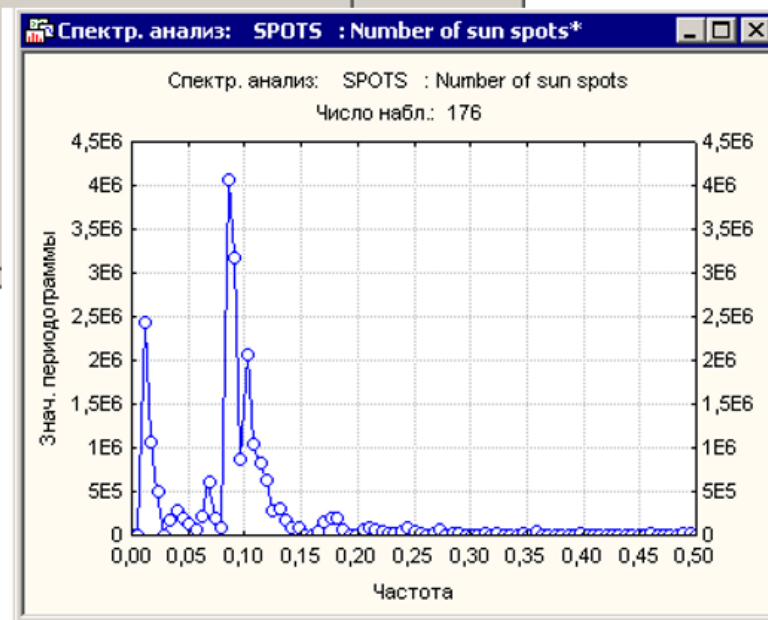
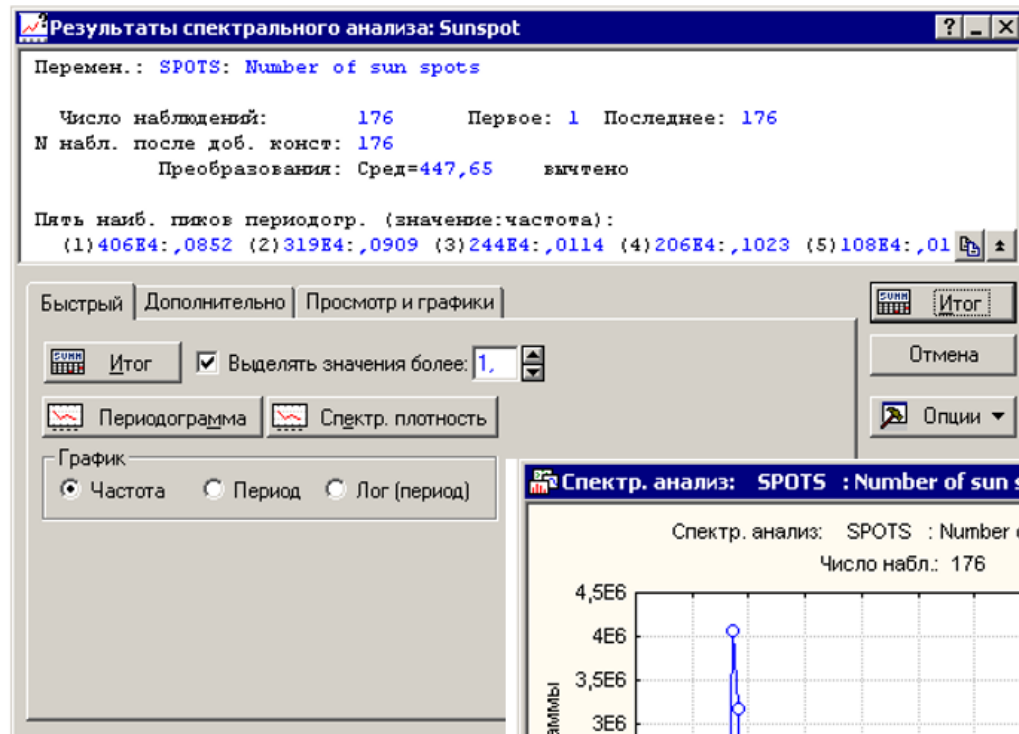

Cluster analysis

Distances between two objects

$$d_S(x_i; y_i) = \left(\sum_{i=1}^{Nf} |x_i - y_i|^p \right)^{\frac{1}{p}}$$

$$d_M(x_i; y_i) = \sqrt{\sum_{i=1}^{Nf} (\sqrt{x_i} - \sqrt{y_i})^2}$$

$$d_E(x_i; y_i) = \sqrt{\sum_{i=1}^{Nf} (x_i - y_i)^2}$$

$$d_{SUP}(x_i; y_i) = SUP|x_i - y_i|$$

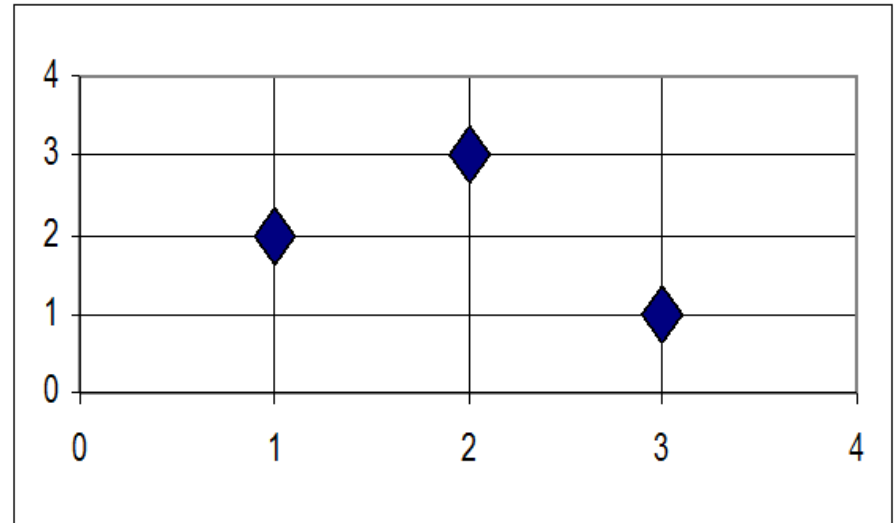

Representation of three objects,
as points on a plane

$$d_{XEM}(x_i; y_i) = \sum_{i=1}^{Nf} (x_i - y_i)$$

$$d_L(x_i; y_i) = \sum_{i=1}^{Nf} |x_i - y_i|$$



Clustering with complete overview of

objects

$$Z = \sum_{i=1}^{N_0} \sum_{j=1}^{N_0} q_{ij} d_{ij} \rightarrow \max$$

$$\sum_{i=1}^{N_0} q_{ij} \leq N_0$$

$$\sum_{j=1}^{N_0} q_{ij} = 1$$

$$\sum_{i=1}^{N_0} \sum_{j=1}^{N_0} q_{ij} = N_0$$

	1	2	3	4	5
1	0	0,89	0,41	0,74	0,46
2	0,89	0	0,86	0,87	0,61
3	0,41	0,86	0	0,96	0,66
4	0,74	0,87	0,96	0	0,62
5	0,46	0,61	0,66	0,62	0

		Objects					Amount by clusters
		1	2	3	4	5	
Clusters	1	0	1	0	0	0	1
	2	1	0	0	0	0	1
	3	0	0	0	1	1	2
	4	0	0	1	0	0	1
	5	0	0	0	0	0	0
Amount by columns		1	1	1	1	1	5



Dispersion analysis (continued)

- Student's criterion is used to determine how likely it is that two samples from the general population have the same mean.
- If the probability is small (<0.55), we can assume that the samples have significantly different meanings, and therefore they can not be combined in one to construct a mathematical model.
- To implement this distribution law, there is the TTEST function
- TTEST (Data 1; Data 2; Mode; Type)
- The F-test (Fisher) determines the one-way probability that the variance of the arguments array1 and array2 differ insignificantly. This function is used to determine if there are two different variances in the sample. If the probability is small (<0.55), this means that the variance of the sample varies significantly, and therefore, simulation can not use data from the samples at the same time.
- To implement this test, there is the FTEST function
- FTEST (array1; array2)



4. METHODOLOGY AND METHODS OF SYNTHESIS OF MODELS OF SOCIO-ECONOMIC SYSTEMS

Creation of models of social and economic systems

This direction of scientific activity can be divided into three types:

The first type is the development of models when the structure of the socio-economic system is known. For example, develop a profit model for an enterprise that produces TVs, video recorders and music centers, if the price of these products is 1200, 800 and 950 UAH respectively. Each type of product includes four components, which have a price of 0.8, respectively; 1.2; 3.3; and 4.4 UAH. In each type of product, these components come in the following quantities: for TV - 1, 5, 8, 4 pcs .; for VCR - 0, 8, 6, 2 pcs .; for the music center - 4, 8, 3, 1 pc. Availability of spare parts in stock, respectively - 12000, 15000, 14000, 45000 pcs. The price of working time per unit of production is 12, 15 and 18 UAH respectively. Continuous costs are not counted.



The second type of scientific activity in the development of models refers to the case when the structure of the socio-economic system is unknown, but the researcher has a hypothesis as to what this structure is. For example, a well-known model of an advertising campaign based on such basic hypotheses. Let $N(t)$ be the number of consumers who know about the product and intend to buy it (t - the time since the beginning of the advertising campaign), the value of dN / dt is the rate of change in the number of already-informed clients. It is assumed that dN / dt is proportional to the number of buyers who are not yet aware of this product (service), that is, the value $a_1(t) (N_p - N(t))$, where N_p is the total number of potential paying customers, $a_1(t) > 0$ characterizes the intensity of the advertising campaign (which is determined by the cost of advertising at a given time).? It is also assumed that those who find out about the product, one way or another spread the information received among the ignorant, acting as additional advertising agents of the firm. Their contribution is determined by the value $a_2(t) (N(t) (N_p - N(t)))$ and will be greater than the larger number of agents. The value $a_2(t) > 0$ characterizes the degree of customer communication among themselves (it can be established by the survey) .The result is the following equation

$$\frac{dN}{dt} = [a_1(t) + a_2(t)N(t)](N_p - N(t)).$$



The third type of scientific activity in the development of models refers to the case where the structure of the socio-economic system is completely unknown. Then the researchers resort to regression analysis, which allows obtaining a formula for communication between input and output factors. The procedure described below is statistically not precise, but it is quite sufficient for practical application in solving microeconomic problems.



Synthesis of statistical linear and quasilinear models

Possible transformations

$$y = a_0 + \sum_{i=1}^K a_i x_i \quad y = a_0 \ell^{a_i x_i} \quad y = a_0 \log_n x$$

$$y = a_0 + \sum_{i=-n}^{-1} a_i x^i \quad x_1 x_2, x_1 / x_2, x_1 - x_2, \log x_1 x_2,$$

An example of normalization-denormalization

$$y = a_0 + a_1 x + a_2 x^2 \quad y = \left[M_y + \sigma_y \left(a_0 - \frac{a_1 M_x}{\sigma_x} - \frac{a_2 M_{x2}}{\sigma_{x2}} \right) \right] + \frac{a_1 \sigma_y}{\sigma_x} x + \frac{a_2 \sigma_y}{\sigma_{x2}} x^2$$

$$\text{Lny} = a_0 + a_1 * \text{Lnx}_1 + a_2 * \text{Lnx}_2$$

$$\text{Lny} = \left[M_y + \sigma_y \left(a_0 - \frac{a_1 M_x}{\sigma_x} - \frac{a_2 M_{x2}}{\sigma_{x2}} \right) \right] + \frac{a_1 \sigma_y}{\sigma_x} \text{Lnx}_1 + \frac{a_2 \sigma_y}{\sigma_{x2}} \text{Lnx}_2$$



Synthesis of autoregressive models

Profitability	Preliminary value of profitability
5%	-
4%	5%
1%	4%
12%	1%

Synthesis of periodic models

$$y = Ax^B + C(1 - e^{Dx})$$

$$\sin(Ex^F + G) + H$$

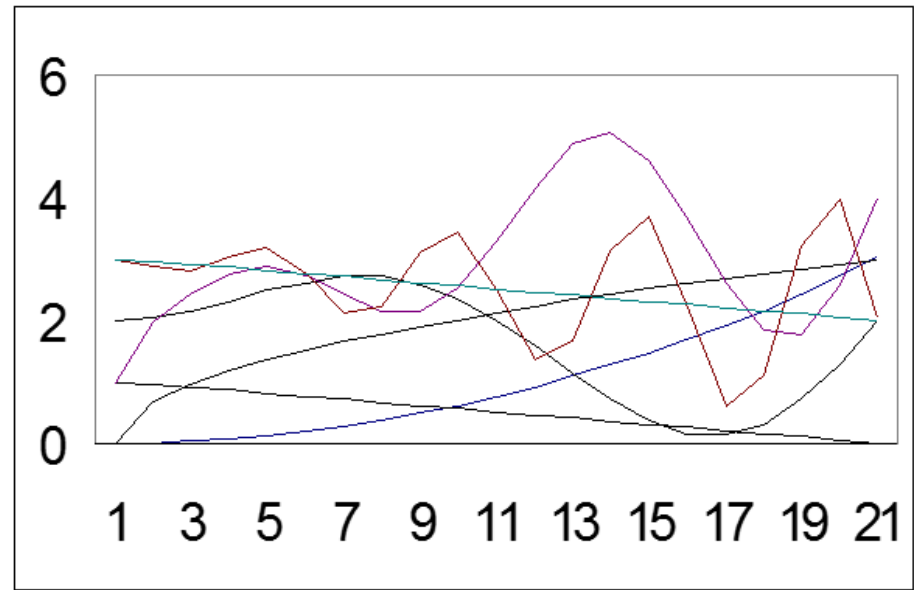

An example of a periodic model

$$C_{t,1} = 1,342c_{t-12,1}^{0,887} + 0,525(1 - e^{-0,976c_{t-12,1}}) \sin(0,524c_{t-12,1}^{1,187} + 0,664) - 0,402c_{t-24,1}^{0,686} + 0,288(1 - e^{-0,106c_{t-24,1}}) \sin(0,524c_{t-24,1}^{0,808} + 0,195) - 0,146$$

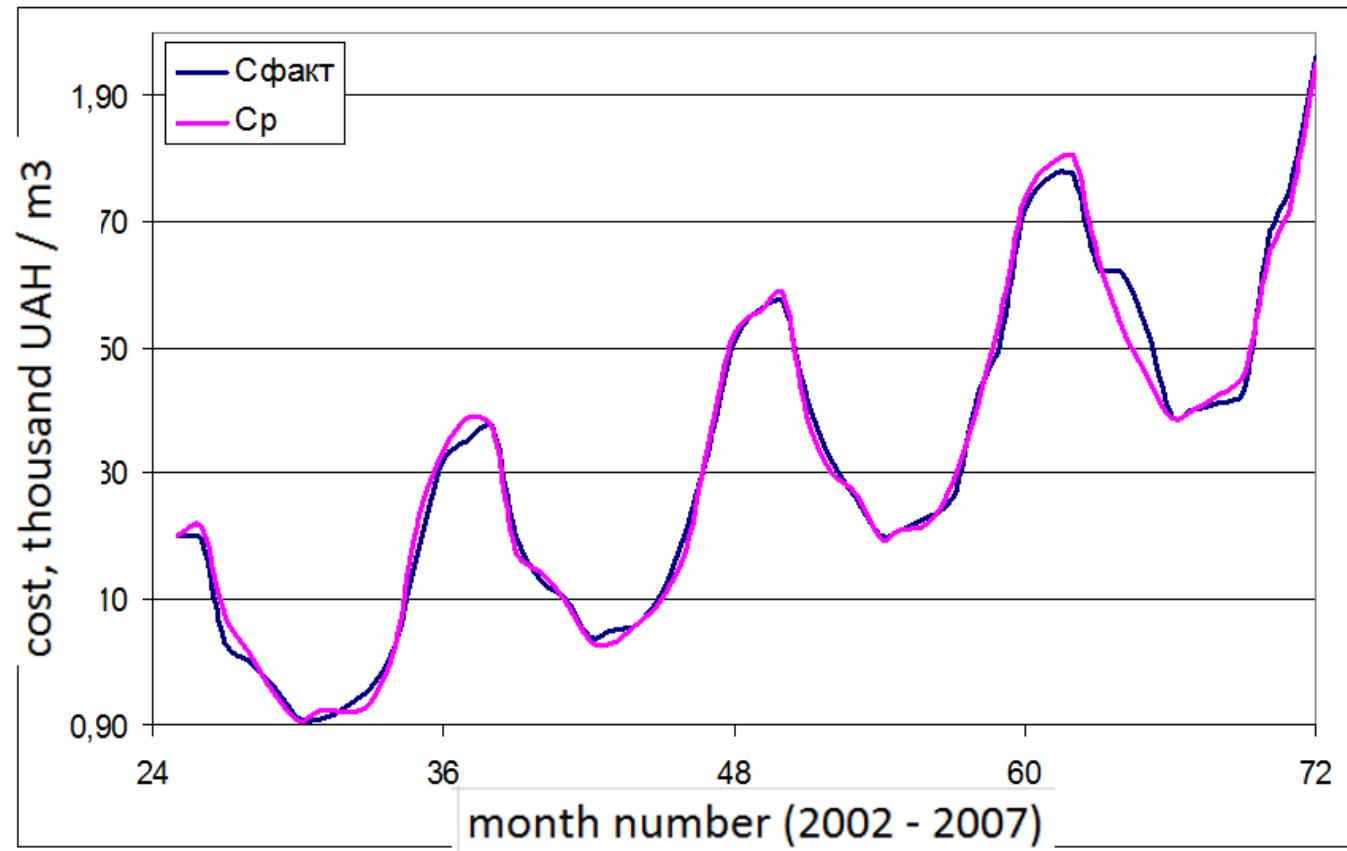

Neural Networks

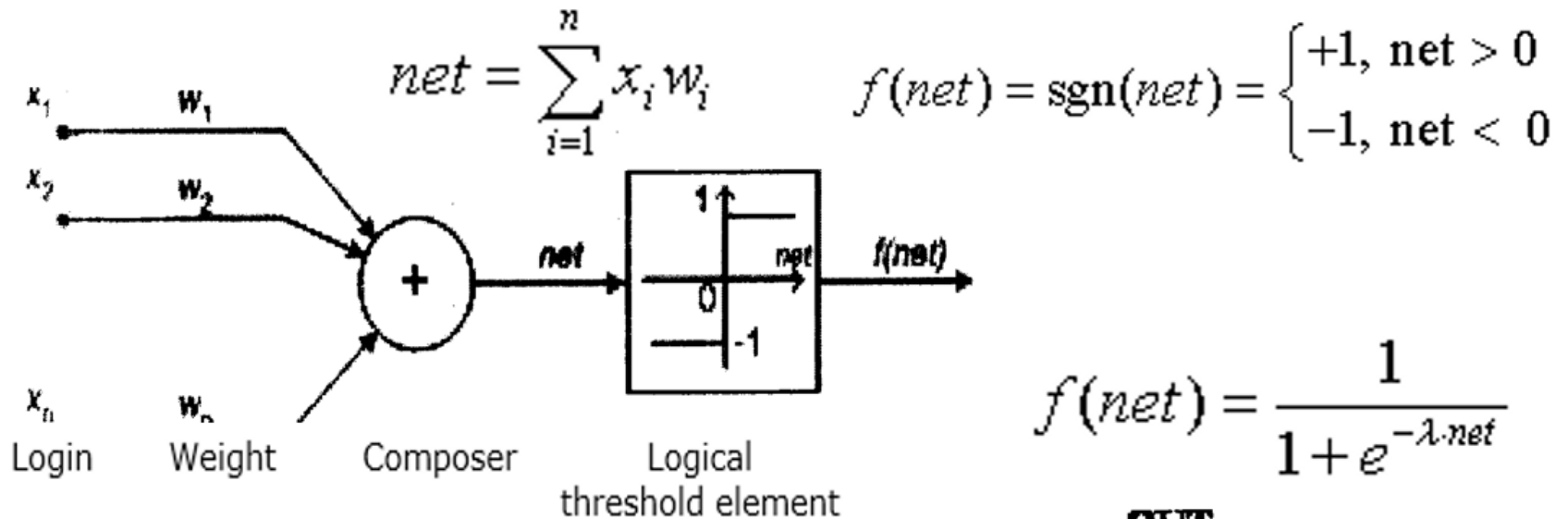

$$f(net) = \frac{1}{1 + e^{-\lambda \cdot net}}$$

McCulloch-Pitts boundary neuron model

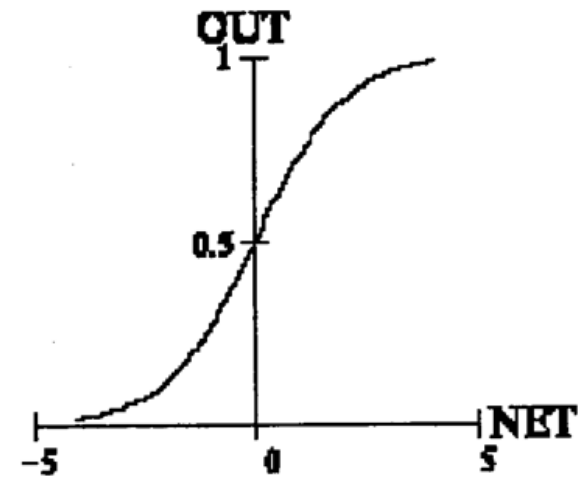

Type of logistics function



Algorithm of perceptron training

- Primary weights may be any. The correction is proportional to the value of the derivative of the given coordinate. The derivative is taken from the activation function. Adjustment of j weight for i neuron is carried out according to the

$$\Delta w_{ij} = \eta [d_i - f(\text{net}_i)] \cdot f'(\text{net}_i) \cdot x_j$$

where $j = 1, 2, \dots, n$ η - learning factor, is selected heuristic

- Error while studying at step k :

$$E_k = \frac{1}{2} [d_i - f(\text{net}_i)]^2$$

where d_i - expected exit

- General learning error:

where p is the number of examples in the training sample

$$E = \frac{1}{2 \cdot p} \sum_{k=1}^p [d_i - f(\text{net}_i)]^2$$

- Derived from sigmoid where p - number of examples in the training sample.

$$f'(\text{net}) = \lambda \cdot f(\text{net}) \cdot [1 - f(\text{net})]$$

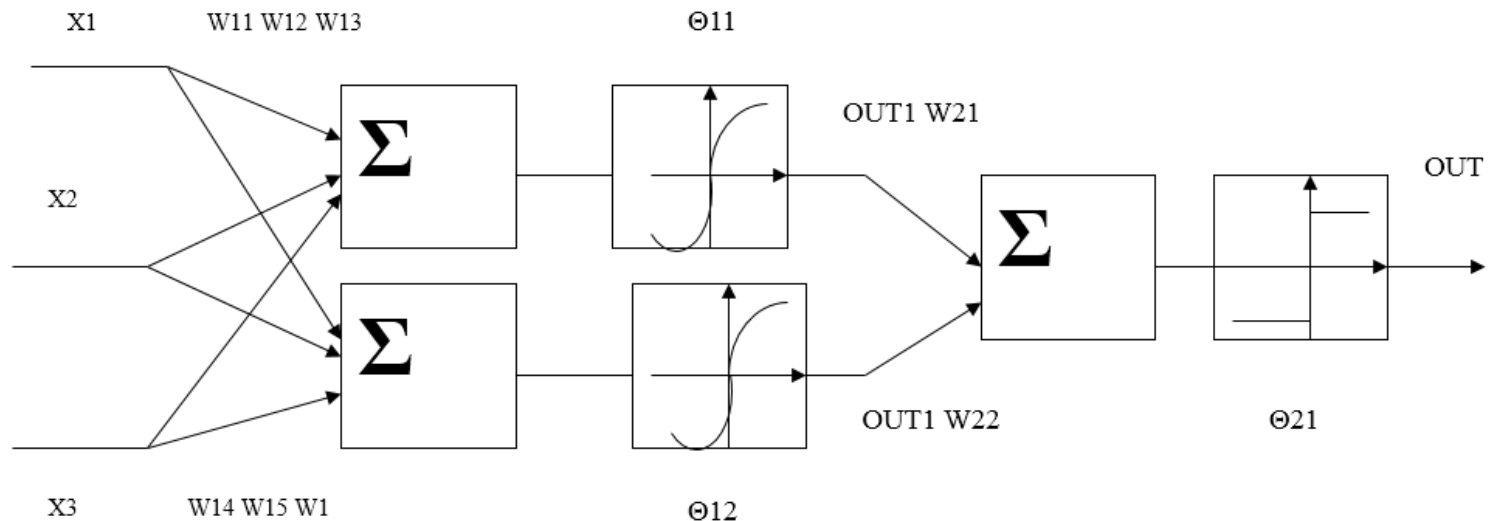

Examples of neural nets

General view of the perceptron scheme with one neuron and adder at the input

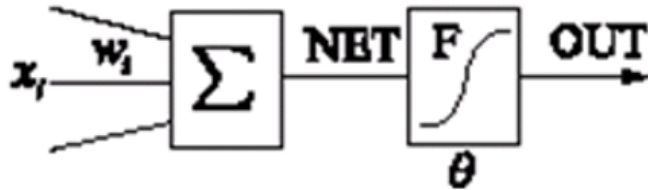

$$OUT = \frac{1}{1 + e^{-(w_1x_i + w_2x_{i+1} + w_3x_{i+2})}}$$

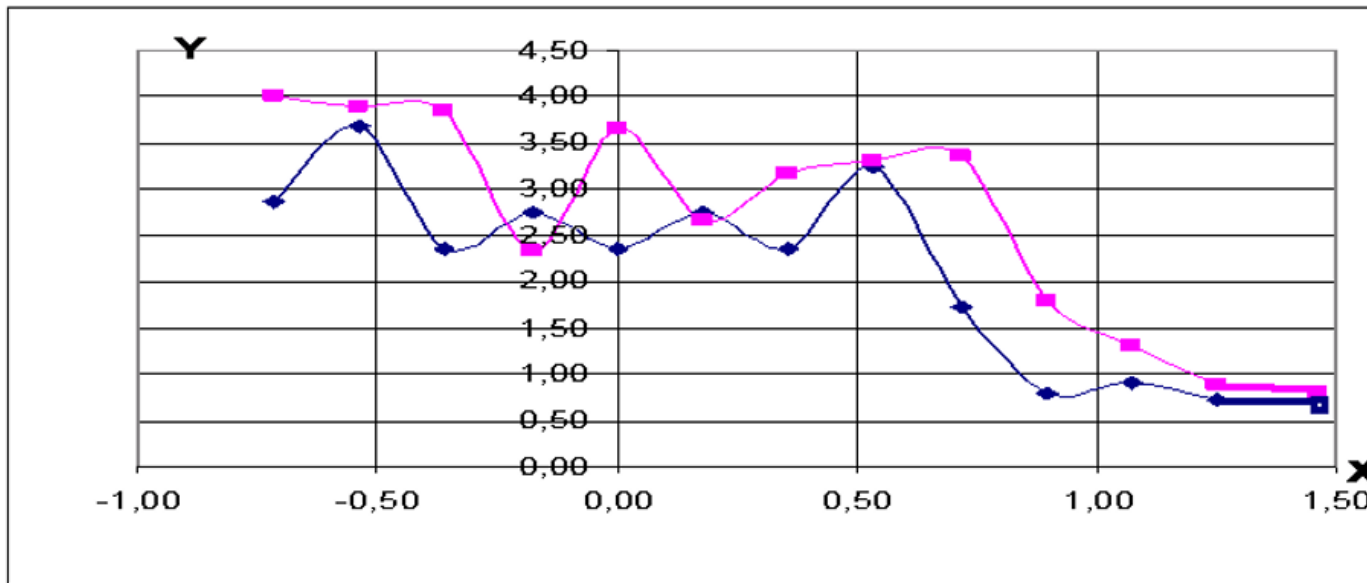

Graph of the number of calls Y per hour of working hours X

- ◆ - experimental curve
- - calculated curve



Scheme of a two-layer perceptron with three inputs on each neuron

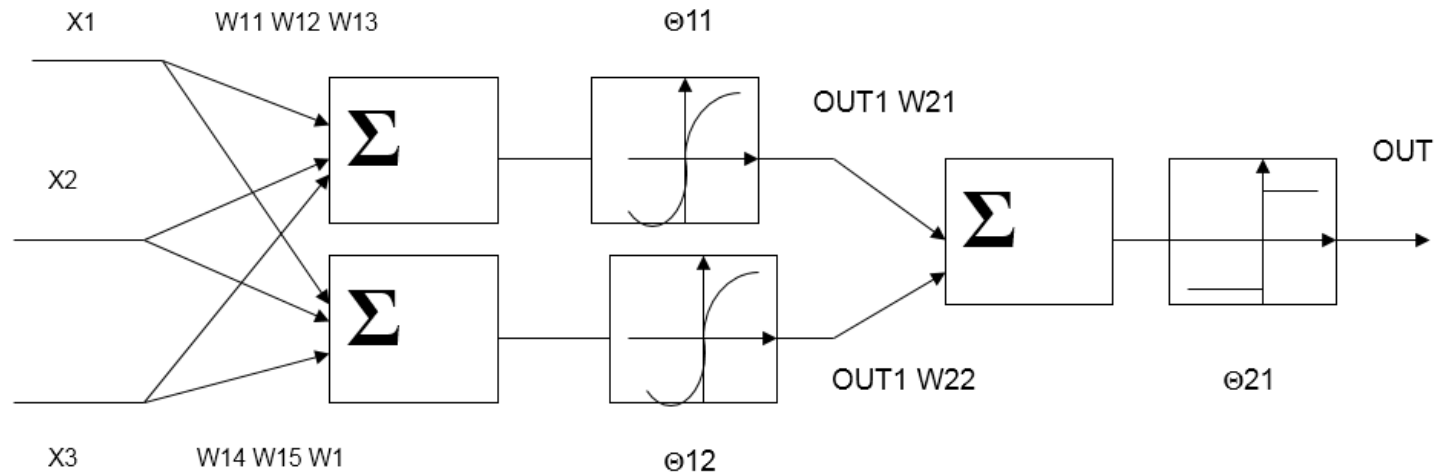

$$\text{OUT} = \text{Sign} \left[\frac{10,37669298}{1 + e^{-(-1,443525248X_1 + 1,561436345X_2 + 1,582503396X_3 + 4,683681367)}} + \frac{7,940045065}{1 + e^{-(-1,556474752X_1 + 4,561436345X_2 + 4,582503396X_4 + 3,683681367)}} + 2,883681367 \right]$$



ASSESSMENT OF QUALITY OF APPROXIMATION AND FORECASTING

The most convenient test is the Pearson criterion, which is conducted in the following order:

1. To verify the adequacy of the approximation, the calculation of the initial values of the mathematical model is made, substituting in it the real input values for which this model was constructed. To determine the quality of prognosis, the values of input factors that are not used in calculating the model coefficients are subjected to the model.

2. For each pair calculated $y_{\Pi i}$ and real values y_{P_i} are calculated by the

criterion "chi-square" by the formula

$$\chi_P^2 = \sum_{i=1}^n \frac{(y_{P_i} - y_{\Pi i})^2}{y_{P_i}}$$

3. Determine the number of degrees of freedom as $r = n - 2$.

4. The theoretical value of the "chi-squared" is determined by the pre-determined probability of confidence. This confidence probability should be sufficiently high so that the researcher could trust the results (0,8-0,99). If this value is more than calculated, the model is adequate with the determined probability of probability. Otherwise - the model is not adequate, that is, it badly describes the process. The quality of forecasting is also understood by this probability.

5. In the case where it is necessary to determine the quality of forecasting, for the construction of the model, only part of the actual values of input and output factors are used. And for the remaining values, the predicted values of the source factor are calculated. then act on pp. 2-4.



Synthesis of dynamic models

Simple delay $y(t) = y^0(t - \tilde{T}); \quad t \geq \tilde{T},$

Frequently used model $\frac{dy(t)}{dt} = -\lambda [y(t) - y^0(t)].$

$$\frac{dy(t)}{dt} + \lambda y(t) = \lambda y^0, \quad y(t) = (1 - e^{-\lambda t}) y^0.$$

Discrete latency models

$$y_\tau = \beta_1 y_{\tau-1}^0 + \beta_2 y_{\tau-2}^0 + \dots = \sum_{\theta=1}^N \beta_\theta y_{\tau-\theta}^0, \quad \beta_\theta \leq \beta_{\theta+1}; \quad \sum_{\theta} \beta_\theta = 1.$$

$$\Delta y_\tau = \lambda [y_\tau^0 - y_\tau],$$

$$\lambda = 1 - r, \quad \text{and } y_{\tau+1} = y_\tau + \Delta y_\tau; \quad \tau = 1, 2, \dots$$



Algebra of logic

Unary logical operations

x	$g_1 (\neg)$	$g_2 (=)$	$g_3 (1)$	$g_4 (0)$
0	1	0	1	0
1	0	1	1	0

Binary logical operations

x	y	$f_1 (\&)$	$f_2 (\vee)$	$f_3 (\equiv)$ $x_1 \approx x_2$	$f_4 (\oplus)$	$f_5 (\subset)$	$f_6 (\supset)$ $x_1 \rightarrow x_2$	$f_7 (\downarrow)$	$f_8 (\uparrow)$
0	0	0	0	1	0	1	1	1	1
0	1	0	1	0	1	0	1	0	1
1	0	0	1	0	1	1	0	0	1
1	1	1	1	1	0	1	1	0	0
x	y	f_9	f_{10}	f_{11}	f_{12}	f_{13}	f_{14}	f_{15}	f_{16}
0	0	0	0	1	1	0	0	1	0
0	1	0	1	1	0	0	1	1	0
1	0	1	0	0	1	1	0	1	0
1	1	0	0	0	0	1	1	1	0



Properties of logical operations

1. Commutative: $xy = yx$ $\circ \in \{\&, \vee, \oplus, \sim, |, \downarrow\}$.

2. Identity: $xx = x$ $\circ \in \{\&, \vee\}$.

3. Associativity: $(xy)oz = x(yz)$ $\circ \in \{\&, \vee, \oplus, \sim\}$.

4. Distribution of conjunctions and disjunctions

Regarding disjunction, conjuncture and modulus amount two respectively:

- $x \wedge (y \vee z) = (x \wedge y) \vee (x \wedge z)$,

- $x \vee (y \wedge z) = (x \vee y) \wedge (x \vee z)$,

- $x \wedge (y \oplus z) = (x \wedge y) \oplus (x \wedge z)$.

4. The laws of de Morgan:

- $\neg(x \wedge y) = (\neg x) \vee (\neg y)$,

- $\neg(x \vee y) = (\neg x) \wedge (\neg y)$.

5. Laws of absorption:

- $x \wedge (xy) = x$

- $x \vee (xy) = x$.

6. Others (1):

- $x \wedge (\neg x) = x \wedge 0 = x \oplus x = 0$.

- $x \vee (\neg x) = x \vee 1 = x \sim x = x \rightarrow x = 1$.

- $x \vee x = x \wedge x = x \wedge 1 = x \vee 0 = x \oplus 0 = x$.

- $x \oplus 1 = x \rightarrow 0 = x \sim 0 = x | x = x \downarrow x = \neg x$.

- $\bar{\bar{x}} = x$.

7. Others (2):

- $x \oplus y = (x \wedge \bar{y}) \vee (\bar{x} \wedge y) = (x \vee y) \wedge (\bar{x} \vee \bar{y})$.

- $x \sim y = \overline{x \oplus y} = (x \wedge y) \vee (\bar{x} \wedge \bar{y}) = (x \vee \bar{y}) \wedge (\bar{x} \vee y)$

- $x \rightarrow y = \bar{x} \vee y = ((x \wedge y) \oplus x) \oplus 1$.

8. Others (3) (Addition of de Morgan's laws):

- $x | y = \neg(x \wedge y) = \neg x \vee \neg y$.

- $x \downarrow y = \neg(x \vee y) = \neg x \wedge \neg y$.

9. The laws of gluing:

$$(a \vee \bar{b}) \wedge (a \vee b) = a$$

$$(a \wedge \bar{b}) \vee (a \wedge b) = a$$

10. Two more obvious laws

$$x \vee \bar{x} = 1; \quad x \wedge \bar{x} = 0.$$



In algebra of logic, logical connections and their corresponding logical operations have special names and are denoted as follows:

Logical connection	The name of the logical operation	Marking
Not	Denial, inversion	$\neg, \bar{\quad}$
And, but	Conjunction, logical multiplication	$\&, \cdot, \wedge$
Or	Disjunction, logical addition	$\vee, +$
If...then	Implication, follow up	\Rightarrow, \rightarrow
Then and only when	Equivalence	$\Leftrightarrow, \sim, \equiv, \leftrightarrow$



Fuzzy models

The function of belonging $A = \{x/mA(x)>0\}$.

Triangular Types of belonging functions Trapezoid

$$MF(x) = \begin{cases} 1 - \frac{b-x}{b-a}, & a \leq x \leq b \\ 1 - \frac{x-c}{c-b}, & b \leq x \leq c \\ 0, & \text{in other cases} \end{cases}$$

$$MF(x) = \begin{cases} 1 - \frac{b-x}{b-a}, & a \leq x \leq b \\ 1, & b \leq x \leq c \\ 1 - \frac{x-c}{d-c}, & c \leq x \leq d \\ 0, & \text{in other cases} \end{cases}$$

Gaussian

$$MF(x) = \exp \left[- \left(\frac{x-c}{\sigma} \right)^2 \right]$$

Circular

$$\mu(x) = \frac{1}{1 + \frac{(x-a)^2}{b}}$$

$$\mu(x) = a \sqrt{\frac{x}{x_{max}} \left(1 - \frac{x}{x_{max}} \right)}$$



An example of the appearance of membership functions

Triangular

Trapezoidal

Gaussian

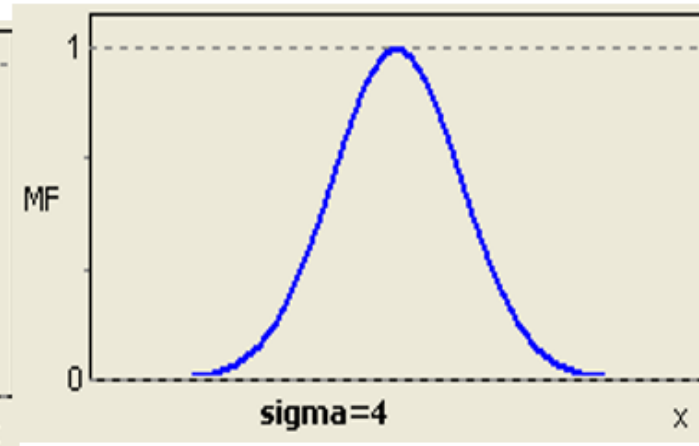
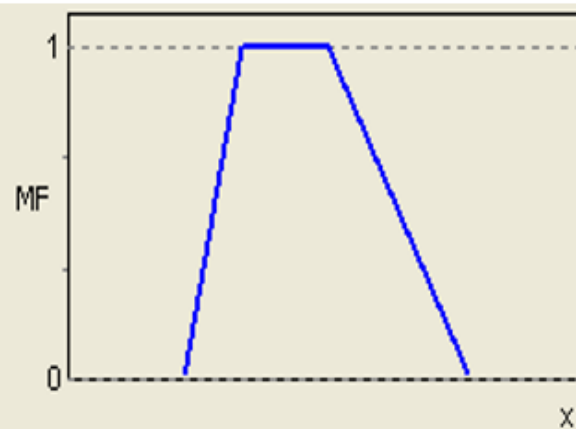
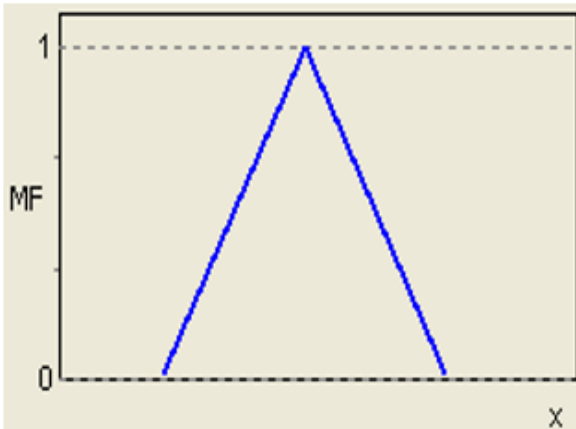

The structure of the fuzzy control system

IF x_1 is A_1 . AND . x_2 is A_2 , THEN y is B .



SELECTIVE FUNCTIONS

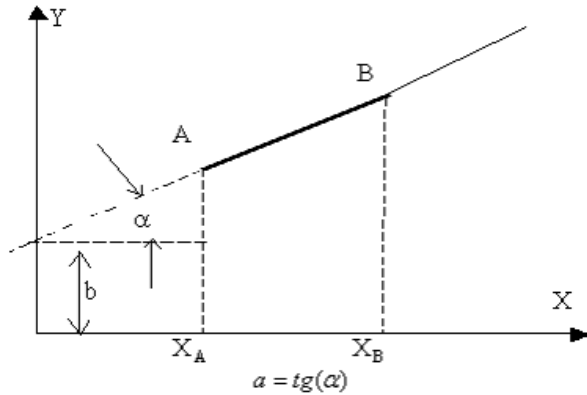

$$y = Si(x, x_A, x_B) \cdot (a \cdot x + b)$$

$$sign(a) = \begin{cases} 1, & \text{при } b > 0; \\ 0, & \text{при } b = 0; \\ -1, & \text{при } b < 0; \end{cases}$$



The look of the function sgn (x)

$$sgn(a) = \begin{cases} 1, & \text{при } b \geq 0; \\ -1, & \text{при } b < 0. \end{cases}$$

$$Si(x, x_{\min}, x_{\max}) = \frac{1}{2} \cdot \{1 + sgn[(x - x_{\min}) \cdot (x_{\max} - x)]\}$$

$$Si(x, x_{\min}, x_{\max}) = sign\{1 + sign[(x - x_{\min}) \cdot (x_{\max} - x)]\}$$

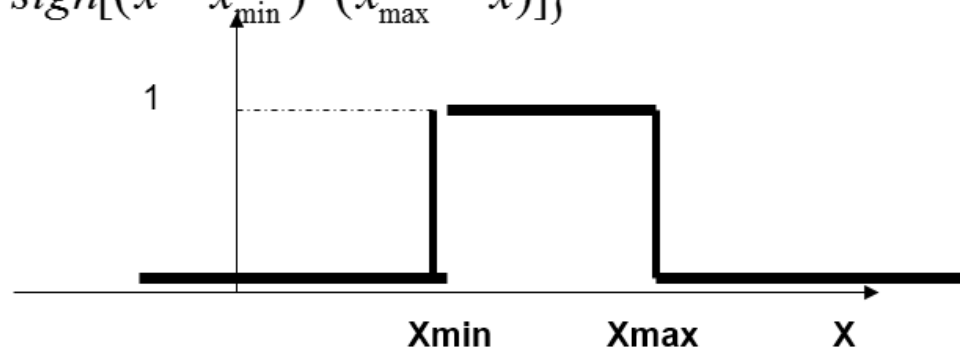

5. THEORY OF OPTIMAL SYSTEMS AND ITS APPLICATION IN OPTIMIZATION OF MANAGEMENT PROCESSES IN ECONOMY

Economic and mathematical models make it possible to make a choice of a set of numbers x_i (variables in equations) that provide the extremum of some function Z (target function or quality indicator of an approved solution) under the constraints defined by the operating conditions of the system. The model is written as follows: calculate the vector that rotates at the maximum or minimum $\bar{X} = x_1, x_2, x_3, \dots, x_j, \dots, x_n$, target function

$$z = f(\bar{X}) = f(x_1, x_2, x_3, \dots, x_j, \dots, x_n) \quad (1)$$

for condition

$$\left. \begin{aligned} q_i(x_1, x_2, x_3, \dots, x_j, \dots, x_n) &= 0 \quad (i = 1, 2, 3, \dots, m_1); \\ q_i(x_1, x_2, x_3, \dots, x_j, \dots, x_n) &\leq 0 \quad (i = m_1 + 1, m_1 + 2, \dots, m); \\ x_j &\geq 0 \quad (j = 1, 2, 3, \dots, n). \end{aligned} \right\} \quad (2)$$

Expressions of type (2) are called constraints that define the region of solutions of the objective function (1). It is the target function, partly, and is a model of the socio-economic system. It is worth noting that the type of functions f and q_i can be both linear and nonlinear.



EXAMPLE OF CONSTRUCTION OF THE REAL TASK

Price of commodity products: TV - 180 USD, video recorder - 260 USD, music center - 420 USD

The cost consists of the cost of renting an area - 4000 USD, the cost of components - 100, 170, 315 respectively for the release of one TV, VCR and music center; other expenses - 4500 y. at.

The required salary of engineers is 400, the director - 600, the workers on the conveyor - 350. For the enterprise of our scale, there are 3 directors, regardless of issue and 1 per 150 units of production. It is necessary 1-2 engineers for every 150 production units. The wage fund is limited due to tax problems at 260.5 million USD.

In total there are 230 seats, each of which occupies 7.4 square meters, taking into account passages to them. It is also necessary to deploy at least 10 jobs for engineers, each of which occupies 8.5 square meters. The total area of production space is 2000 square meters.

The area necessary for placing the finished product of each type is:

0,3 - for TVs that are issued for a month;

0.35- for VCRs issued per month;

0,4 - for musical centers, let out for a month.



EXAMPLE OF SOLVING NONLINEAR MATHEMATIC PROGRAMMING

FUNCTIONAL

$$\frac{\sum_{i=1}^{19} k_{1i} x_i}{\sum_{i=1}^{19} \left[\frac{k_{1i}}{k_{1i} + k_{2i}} - (a + b \ln x_i) \right] + 1} \rightarrow \max$$

Limitation

- on the warehouse area and the height of the boxes

$$\sum_{i=1}^n s_i x_i \leq S * 5$$

- on the upper and lower limits of trade turnover

$$Q_{1i} \leq x_i \leq Q_{2i}$$

Українська класика 1 л

$$y = 0,7366 \ln(x) - 4,8973$$

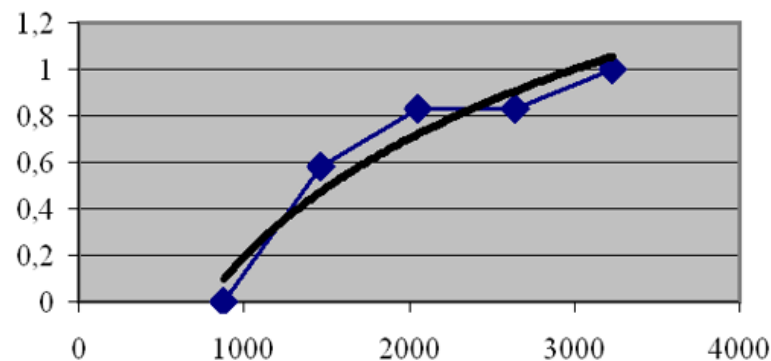

- the type of variables

$$x_i \geq 0$$

$$(1 \leq i \leq n)$$



Coefficients of exponential smoothing of functions demand distribution on certain types of goods.

№		A	B
1	Вина кріплені	0,25	-0,74
2	Вина сухі	0,38	-1,27
3	Вина СК	0,08	-0,012
4	ДАР 0,2	0,83	-6,6
5	ДАР 1	1,24	-10,57
6	ДАР 1,5	1	-7,55
7	Сандорік 0,2	0,83	-6,29
8	Садочок 0,2л	0,58	-4,7
9	Садочок 0,5л	2,38	-16,9
10	Садочок 1л	0,93	-8,21
11	Садочок 1,5л	0,65	-4,81
12	Соки "Українська класика" 1л	-0,73	-4,89
13	Соки "Фрукти світу" 1л	0,19	-6,79
14	Соки Класик 1л	1,35	-10,31
15	Соки Gold 1,5л	0,77	-5,72
16	Соки Gold 1л	1,12	-10,07
17	Соки Gold 0,25л	1,02	-7,88
18	Напої 0,2	0,22	-0,49
19	Напої 1	0,24	-0,61

Frequency analysis of consumption of products

x_i мин	x_i макс	Теоретична кількість діапазони	Кр ок	Розрахунок правої межі інтервалів								
				40	47	88	128	168	208	248	288	328
7	328	29	40	47	88	128	168	208	248	288	328	
29	406	34	47	76	124	171	218	265	312	359	406	
0	656	60	82	82	164	246	328	410	492	574	656	
2520	1064 2	740	101 5	3535	4550	5566	6581	7596	861 1	962 6	106 42	
4820	1133 7	593	815	5635	6449	7264	8079	8893	970 8	105 23	113 37	
1809	5028	293	402	2211	2613	3016	3418	3821	422 3	462 6	502 8	
1471	5044	325	447	1918	2364	2811	3257	3704	415 1	459 7	504 4	
3415	1157 5	743	102 0	4435	5455	6475	7495	8515	953 5	105 55	115 75	
0	1812	165	226	226	453	679	906	1132	135 9	158 5	181 2	
9507	3159 7	2012	276 1	12268	15029	17790	2055 2	2331 3	260 74	288 35	315 97	
1031	5200	380	521	1552	2074	2595	3116	3637	415 8	467 9	520 0	
0	3231	294	404	404	808	1212	1615	2019	242 3	282 7	323 1	
0	994	91	124	124	248	373	497	621	745	870	994	
3066	6415	305	419	3485	3903	4322	4740	5159	557 8	599 6	641 5	
1000	3981	271	373	1373	1745	2118	2490	2863	323 6	360 8	398 1	



Wilson's formula

Enter the following notation: A - the cost of placing and fulfilling the order; S - annual resource requirement; q - the size of a single delivery; r - interest rate on storage of resources (discount rate); p - price of unit of purchased resources, C_{CB} - total expenses for a certain period of time (for simplification of calculations, the period of time is usually taken equal to one year); C_p - the cost of placing an order; C_x - expenses on storage of resources, C_3 - expenses for purchase of resources.

The total cost of the material flow is determined by the following known formula:

$$C_{CB} = C_p + C_x + C_3.$$

In the expanded form, the formula will be as follows:

$$C_{CB} = \frac{AS}{q} + \frac{rpq}{2} + Sp.$$

The minimum value is at the point of its extremum. If we take the derivative in q and equate to zero, then the result will be:

$$-\frac{AS}{q^2} + \frac{rp}{2} = 0$$

Accordingly, the point of the extremum of the function, the minimum cost and the optimal size of delivery will be at the point of q_{opt} . Solving the equation for q, we obtain:

$$q_{opt} = \sqrt{\frac{2AS}{rp}}$$



Numerical methods for finding the optimal solution for statistical models:

Newton's method

$$f'(x_n) = \operatorname{tg} \alpha = \frac{\Delta y}{\Delta x} = \frac{f(x_n) - 0}{x_n - x_{n+1}} = \frac{0 - f(x_n)}{x_{n+1} - x_n},$$

$$x_{n+1} = x_n - \frac{f(x_n)}{f'(x_n)}.$$

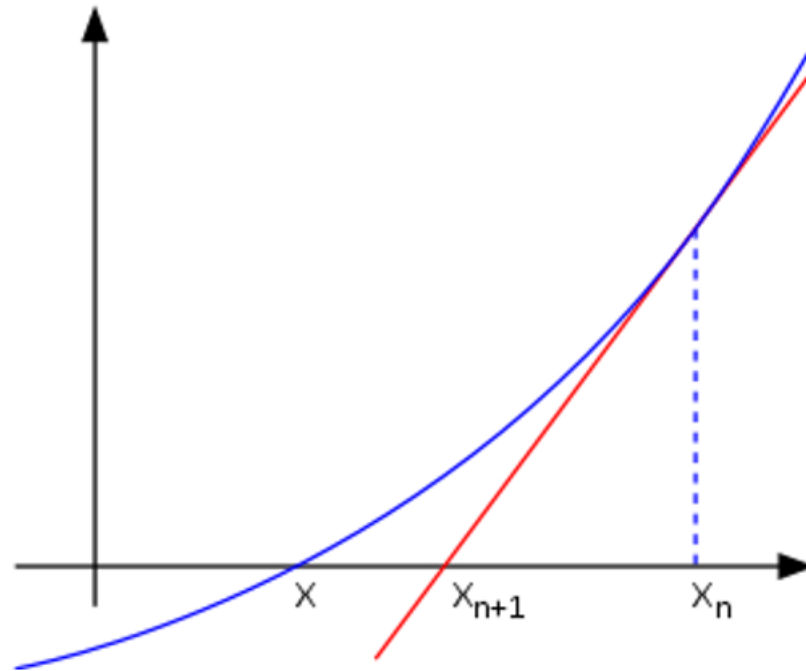

Geometric interpretation of Newton's method



Functions of Bessel in mathematics are a family of functions that are canonical solutions of the Bessel differential equation:

$$x^2 \frac{d^2 y}{dx^2} + x \frac{dy}{dx} + (x^2 - \alpha^2)y = 0,$$

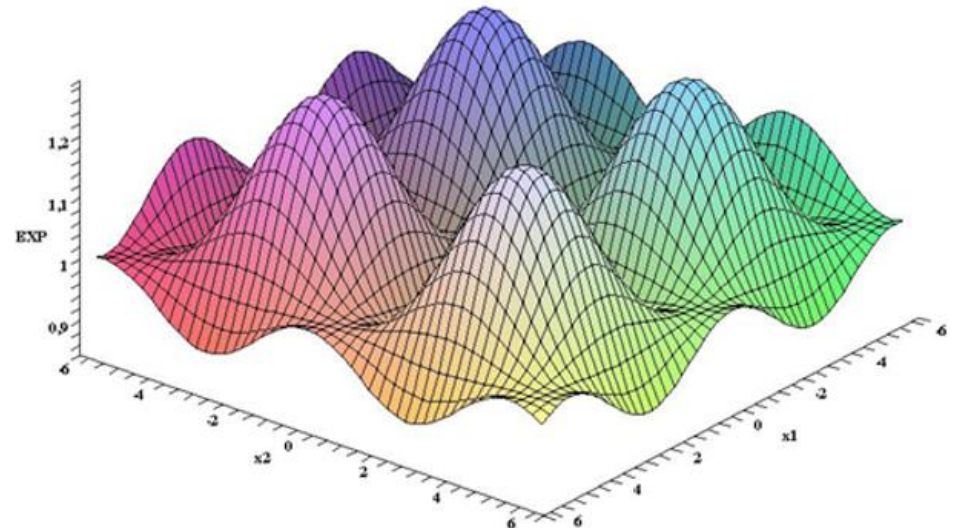
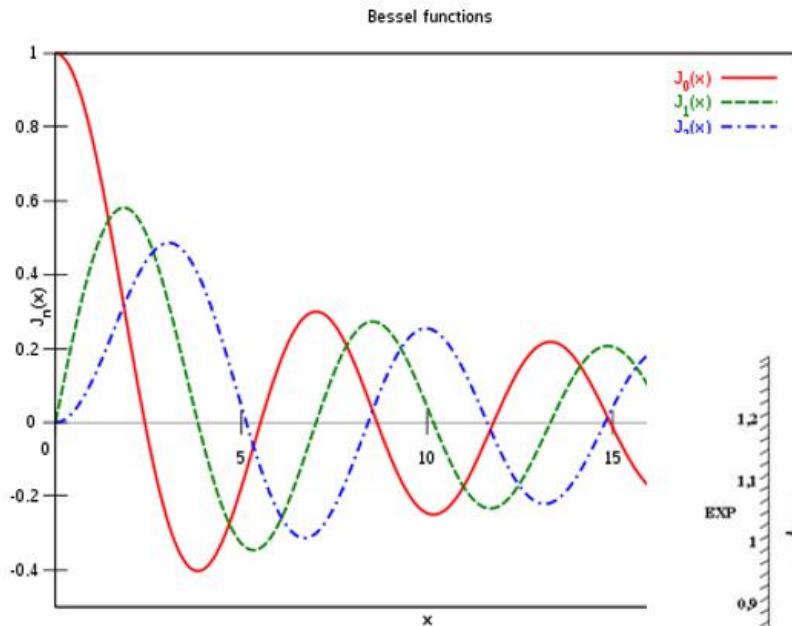

Multicriteria tasks

$$L^r(x) = \sum_{j=1}^n c_j^r \cdot x_j + c_0^r \rightarrow \max_x, \quad r = \overline{1; R},$$

$$D_x \begin{cases} \sum_{j=1}^n a_{ij} x_j \geq -b_i, \Rightarrow \mathcal{E}_i = \sum_{j=1}^n a_{ij} x_j + b_i, i = \overline{1; m}, \\ x_j \geq 0, \quad j = \overline{1; n}, \end{cases}$$

The formal definition of the \square -optimality of the solution x is written as a requirement for the absence of such a solution $x \in Dx$, at which conditions the conditions were fulfilled

$$L^r(x) \geq L^r(x'), \quad \forall r,$$

and at least one of them - strictly (with a sign $>$).



Summary to the problem of mathematical programming

$$\delta^r = L^r(x) - L^r(x') = \sum_{j=1}^n c_j^r x_j - \sum c_j x_j', \forall \delta^r,$$

$$\Delta = \Delta(x) = \sum_{r=1}^R \delta^r \rightarrow \max_x, \quad x \in D_x, \forall x_j \geq 0.$$

Guaranteed result method

$$\varphi = \varphi(x) = \min_{1 \leq r \leq R} L^r(x) \rightarrow \max_x$$



Method of convolution of partial criteria

$$L(x) = \sum_{r=1}^R \mu_{\hat{e}} L^r(x), \quad \frac{L^r(x) - L_{OIII}^r(x)}{L_{OIII}^r(x)}$$

$$L_{MAX}^r(x) = \frac{1}{L_{MIN}^r(x) + 1} \quad L(x) = \frac{\sum_{r=1}^R \mu_{\hat{h}} L_{MIN}^r(x) + 1}{\sum_{r=1}^R \mu_{\hat{h}} L_{MAX}^r(x)},$$



TRANSPORT TASK

Matrix statement of transport task:

Let there be a number of points of consumption and suppliers of some products, where A_i - resource of the i -th supplier (stock of products or plan of shipment from the current production).

V_j - the requirements for the same product in points j .

C_{ji} - distance or cost of transportation from i to j .

It is required to find such deliveries from each vendor to each customer, X_{ij} (task variables), in which the total cost or total mileage will be minimal.

	Need	Recipients				
Stocks		B_1	B_2	B_3	B_m
Warehouses	A_1	C_{11}	C_{12}	C_{13}	...	C_{1m}
	A_2	C_{21}	C_{22}	C_{23}	...	C_{2m}
	A_3	C_{31}	C_{32}	C_{33}	...	C_{3m}
	...					
	A_n	C_{n1}	C_{n2}	C_{n3}	...	C_{nm}



Transport task

$$\Sigma X_{ij} = B_i, (j=1,2, \dots n - \text{number of suppliers}),$$
$$\Sigma X_{ij} = A_i, (i= 1,2, \dots m - \text{number of consumers});$$

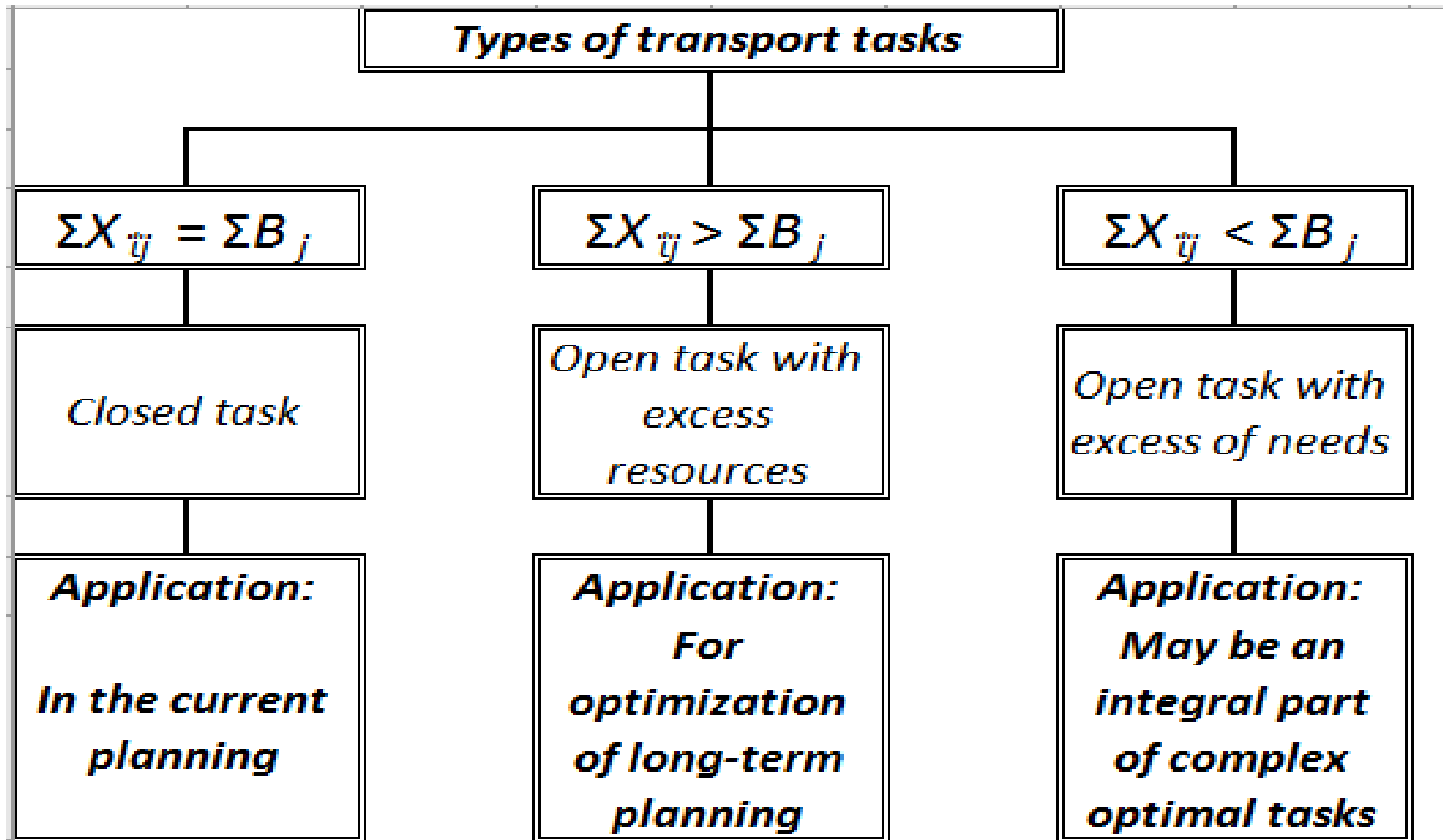

In an open task with an excess of resources, fewer exports can be removed

$$\sum X_{ij} < A_i,$$

In the open task of overcoming the needs of possible supplies less availability

$$\sum X_{ij} < \sum B_j,$$

The criterion for optimality of the solution is a minimum of total transport or mileage costs in ton-kilometers (car-kilometers) for all planned departures. If the cost of transportation (distance) from i to j - denote as C_{ij} the target function will be determined in this way

$$\sum \sum C_{ij} X_{ij} \rightarrow \min,$$



OPTIMAL TRANSFER OF MANUFACTURING OBLIGATIONS OF EMPLOYEES SERVICE ENTERPRISE

Limitation

Criterion for minimizing transport costs

$$F(X) = \sum_{i=1}^N \sum_{j=1}^N C_{ij} \cdot X_{ij} \cdot D_i \cdot P_j \rightarrow \min .$$

$$\sum_{i=1}^N X_{ij} \cdot 10 \leq P_j, i = 1..N,$$

$$\sum_{j=1}^N X_{ij} = D_i, j = 1..N,$$

$$X_{ij} = 0 \text{ або } 1 .$$

An interim plan for moving specialists in the middle of a working day

Enterprise from which we move	Фир- ми	Enterprise to which we move										
		П1	П2	П3	П4	П5	П1	П2	П3	П4	П5	П6
П1	1	1	0	0	0	0	0	0	0	0	0	0
П2	0	0	0	1	0	0	0	0	0	0	0	0
П3	0	0	0	0	0	1	0	0	0	0	0	0
П4	0	0	0	0	1	0	0	0	0	0	0	0
П5	0	0	1	0	0	0	0	0	0	0	0	0
П6	0	0	0	0	0	0	1	0	0	0	0	0
П7	0	0	0	0	0	0	0	1	0	0	0	0
П8	0	0	0	0	0	0	0	0	1	0	0	0
П9	0	0	0	0	0	0	0	0	0	1	0	0
П10	0	0	0	0	0	0	0	0	0	0	1	0
П11	0	0	0	0	0	0	0	0	0	0	0	0
П12	0	0	0	0	0	0	0	0	0	0	0	0
П13	0	0	0	0	0	0	0	0	0	0	0	0
П14	0	0	0	0	0	0	0	0	0	0	0	0

The task of traveling salesman

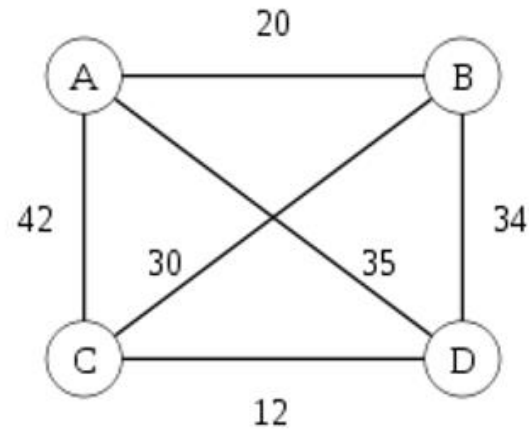

Symmetric TSP for four cities.

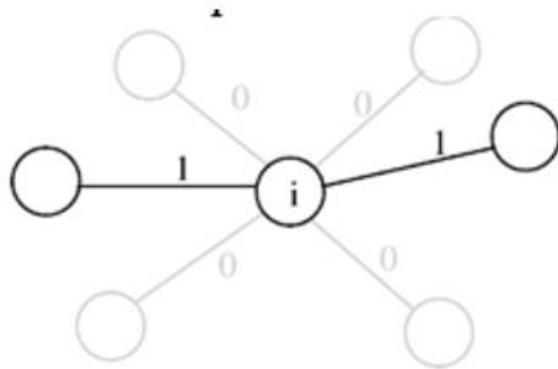

Condition multiplicity: each vertex must have one input and one starting edge of the route.

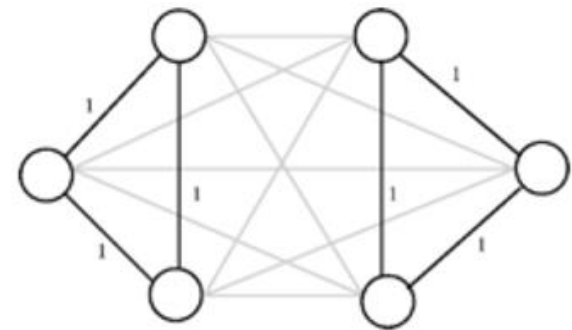

Cycles: variables satisfy condition multiplicity, but not determine the route.



Dynamic programming

The method of dynamic programming is based on the condition of the absence of an aftereffect and the condition of the additivity of the target function.

Condition of absence of aftereffect. State \bar{x}_k , in which the system went over in one step, depends on the state \bar{x}_{k-1} and selected managerial actions (MA) \bar{u}_k and does not depend on how the system came into the state \bar{x}_{k-1} , $\bar{x}_k = f_k(\bar{x}_{k-1}, \bar{u}_k)$.

Similarly, the value of W_k depends on the state \bar{x}_{k-1} and selected MA \bar{u}_k

$$W_k = W_k(\bar{x}_{k-1}, \bar{u}_k).$$

The condition of the additivity of the target function. The total gain for N steps is calculated by the formula

$$S = \sum_{k=1}^N W_k(\bar{x}_{k-1}, \bar{u}_k).$$

Year	The effectiveness of the investment project for one invested hryvnia				
	A	B	C	D	E
1					
2	-1,00	0	-1,00	-1,00	0
3	+0,30	-1,00	+1,00	0	0
4	+1,00	+0,30	0	0	-1,00
	0	+1,00	0	+1,75	+1,40

THEORY OF GAME

Antagonistic game

	Гравець 2	B_1	B_2	B_n	α_i
Гравець 1	A_1	a_{11}	a_{12}	a_{1n}	α_1
	A_2	a_{21}	a_{22}	a_{2n}	α_2

	A_m	a_{m1}	a_{m2}	a_{mn}	α_m
	β_j	β_1	β_2	β_n	

$$\max_i \min_j \alpha_{ij} = \min_j \max_i \alpha_{ij} = v.$$

$$M(A, \bar{p}, \bar{q}) = \sum_{i=1}^m \sum_{j=1}^n a_{ij} p_i q_j$$

$$S_1 = \begin{pmatrix} A_1 & A_2 & \dots & A_m \\ p_1 & p_2 & \dots & p_m \end{pmatrix},$$

$$\text{де } \sum_{i=1}^m p_i = 1, p_i \geq 0$$

$$S_2 = \begin{pmatrix} B_1 & B_2 & \dots & B_n \\ q_1 & q_2 & \dots & q_n \end{pmatrix},$$

$$\text{де } \sum_{j=1}^n q_j = 1, q_j \geq 0;$$



Cooperative (bimatrix) game

$$A = \begin{pmatrix} a_{11} & a_{12} & \dots & a_{1j} & \dots & a_{1n} \\ \vdots & \vdots & \dots & \vdots & \dots & \vdots \\ a_{i1} & a_{i2} & \dots & a_{ij} & \dots & a_{in} \\ \vdots & \vdots & \dots & \vdots & \dots & \vdots \\ a_{m1} & a_{m2} & \dots & a_{mj} & \dots & a_{mn} \end{pmatrix}; \quad B = \begin{pmatrix} b_{11} & b_{12} & \dots & b_{1j} & \dots & b_{1n} \\ \vdots & \vdots & \dots & \vdots & \dots & \vdots \\ b_{i1} & b_{i2} & \dots & b_{ij} & \dots & b_{in} \\ \vdots & \vdots & \dots & \vdots & \dots & \vdots \\ b_{m1} & b_{m2} & \dots & b_{mj} & \dots & b_{mn} \end{pmatrix}; \quad C = \begin{pmatrix} (a_{11}, b_{11}) & (a_{12}, b_{12}) & \dots & (a_{1j}, b_{1j}) & \dots & (a_{1n}, b_{1n}) \\ \vdots & \vdots & \dots & \vdots & \dots & \vdots \\ (a_{i1}, b_{i1}) & (a_{i2}, b_{i2}) & \dots & (a_{ij}, b_{ij}) & \dots & (a_{in}, b_{in}) \\ \vdots & \vdots & \dots & \vdots & \dots & \vdots \\ (a_{m1}, b_{m1}) & (a_{m2}, b_{m2}) & \dots & (a_{mj}, b_{mj}) & \dots & (a_{mn}, b_{mn}) \end{pmatrix}$$

$$M_1^i \leq M_1, \quad i = \overline{1, m}; \quad M_2^j \leq M_2, \quad j = \overline{1, n},$$

$$\sum_{j=1}^n a_{ij} y_j \leq \sum_{i=1}^m \sum_{j=1}^n a_{ij} x_i y_j, \quad i = \overline{1, m}; \quad \sum_{i=1}^m b_{ij} x_i \leq \sum_{i=1}^m \sum_{j=1}^n b_{ij} x_i y_j, \quad j = \overline{1, n}.$$

$$\begin{cases} \sum_{i=1}^m x_i = 1; \quad x_i \geq 0, \quad i = \overline{1, m}; \\ \sum_{j=1}^n y_j = 1; \quad y_j \geq 0, \quad j = \overline{1, n}. \end{cases}$$



Games with nature

Decision making with known probabilities of the state of nature

$$\alpha = \max_i \sum_{j=1}^n a_{ij} p_j$$

In some cases, the probability of occurrence of certain states of nature is given conditioned that the accuracy of determining these probabilities is less than 100%. More often, for each state of nature, π_j indicates its accuracy of calculating the probability of its state t_j , which, as well as the probability varies in the range from 0 to 1 (from about 0% to 100%). In this case, the choice of the optimal strategy of the active player is determined by the involvement of the risk matrix r_{ij}

$$\alpha = \max_i \left(\sum_{j=1}^n a_{ij} p_j t_j - \sum_{j=1}^n r_{ij} p_j (1 - t_j) \right)$$

The matrix R can be constructed directly from the conditions of the problem or on the basis of the matrix of prizes A. The risk of the r_{ij} player when using the strategy A_i and when the environment of π_j is called, we will name the difference between the winnings that a player would receive if he knew that the state of the environment would be π_j , and the winnings the player receives without having this information. That is,

$$R_{ij} = \max_i a_{ij} - a_{ij} .$$



Games with nature

in conditions of complete uncertainty

$$R_{ij} = \max_i a_{ij} - a_{ij}$$

$$A = \begin{pmatrix} & \Pi_1 & \Pi_2 & \dots & \Pi_n \\ A_1 & a_{11} & a_{12} & \dots & a_{1n} \\ A_2 & a_{21} & a_{22} & \dots & a_{2n} \\ \dots & \dots & \dots & \dots & \dots \\ A_m & a_{m1} & a_{m2} & \dots & a_{mn} \end{pmatrix}$$

Maximax criteria

$$M = \max_{1 \leq i \leq m} \max_{1 \leq j \leq n} a_{ij}$$

Maximum Wald criterion

$$W = \max_{1 \leq i \leq m} \min_{1 \leq j \leq n} a_{ij}$$

Minimum risk criterion for Sevgias

$$S = \min_{1 \leq i \leq m} \max_{1 \leq j \leq n} r_{ij}$$

The criterion for pessimism-onmimizm

Hurwitz

$$H_A = \max_{1 \leq i \leq m} \{p \min_{1 \leq j \leq n} a_{ij} + (1-p) \max_{1 \leq j \leq n} a_{ij}\},$$



Optimization of the management of the socioeconomic system, given by the fuzzy model

R1: IF x_1 is A_{11} . And x_n is A_{1n} , the THEN is B_1 .

R $_i$: IF x_1 is A_{i1} . And x_n is A_{in} , THEN B_i .

.....

R $_m$: IF x_1 is A_{m1} . And x_n is A_{mn} , THEN is B_m .

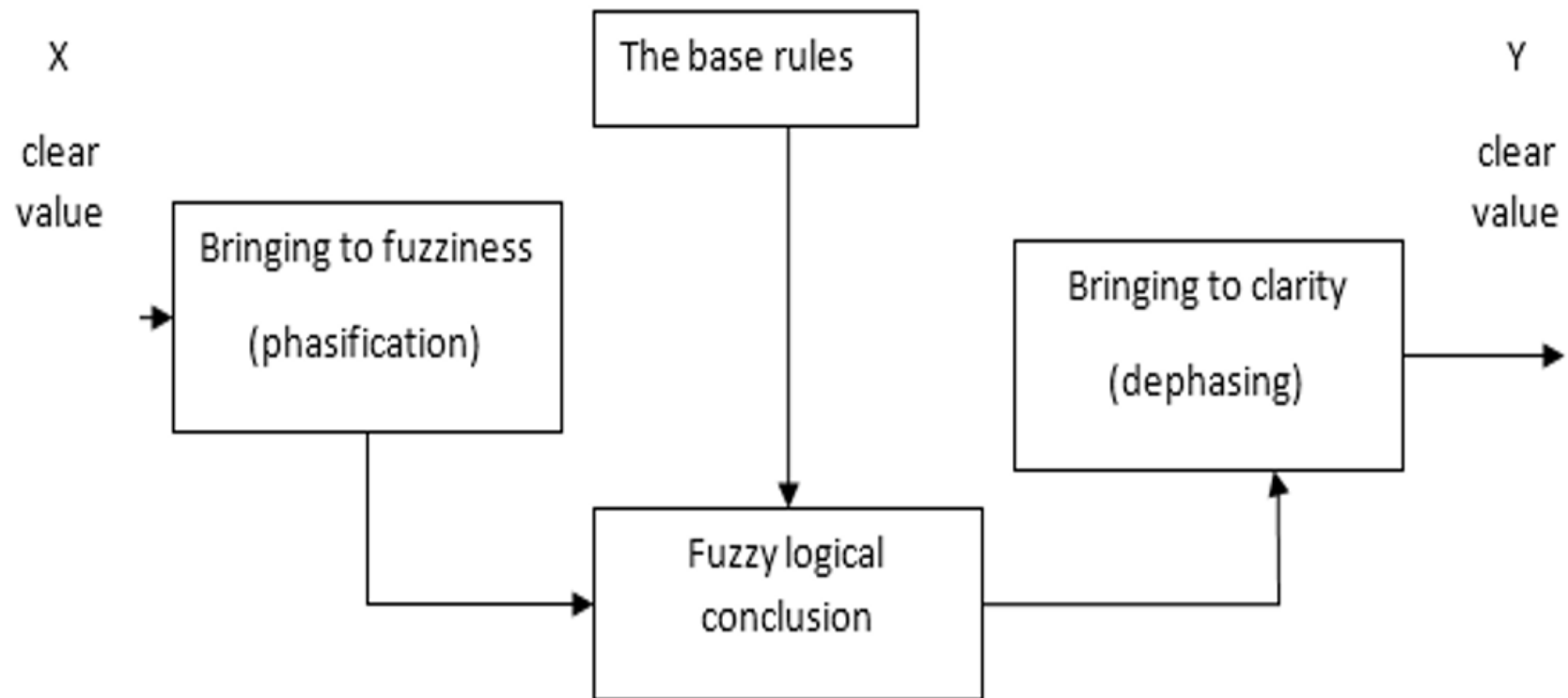

Fuzzy outlet by Mamdani

$$\alpha_i = \min_k(A_{ik}(x_k)) \quad B_i^*(y) = \min(\alpha_i, B_i(y)) \quad MF(y) = \max_i(B_i^*(y))$$

$$y = \frac{1}{y_{\max} - y_{\min}} \int_{y_{\min}}^{y_{\max}} MF(y) dy = \frac{1}{y_{\max} - y_{\min}} \int_{y_{\min}}^{y_{\max}} \max(B_i^*(y)) dy$$

