

Ministry of Education and Science of Ukraine State
Higher Educational Institution "National Mining
University"

Mining faculty
(faculty)

Department of Underground Mining
(full name)

**EXPLANATORY NOTE
of graduation project (work)**

Master

(name of educational qualification level)

branch of knowledge 0503 Mining of mineral deposits
(code and name of knowledge branch)

preparation direction 6.050301 Mining
(code and name of preparation direction)

speciality 8.05030101 Mining and extraction
(code and name of speciality)
of mineral resources

educational level higher education
(name of educational level)

qualification 2147.1 Mining engineer, researcher
(code and name of qualification)

on topic: Planning and development of a hard coal mine under the consideration
of an applicable completely mechanized extraction to ensure a daily
extraction of 30,000 tons of usable material out of two coal beds

Performer:

student of II course, group 184m-16-11-GF

(signature) **Kaisym O. R.**

(surname and initials)

Leaders	Position, surname, initials	Grade	Signature
of project	Prof. Kovalevska I. A.		
of sections:	Prof. Kovalevska I. A.		
Overview	Prof. Kovalevska I. A.		
Technological	Prof. Kovalevska I. A.		
Analytical and research	Prof. Kovalevska I. A.		
Computer modeling	Prof. Kovalevska I. A.		
Reviewer	Prof. Kovalevska I. A.		
Compliance assessment	Prof. Kovalevska I. A.		

**Dnipro
2018**

Міністерство освіти і науки України
Державний вищий навчальний заклад
"Національний гірничий університет"

Гірничий факультет
(факультет)

Кафедра підземної розробки родовищ
(повна назва)

ПОЯСНЮВАЛЬНА ЗАПИСКА
дипломного проекту (роботи)
магістр

(назва освітньо-кваліфікаційного рівня)

галузь знань 0503 Розробка корисних копалин
(шифр і назва галузі знань)
напрямок підготовки 6.050301 Гірництво
(код і назва напрямку підготовки)
спеціальність 8.05030101 Розробка родовищ та видобування
(код і назва спеціальності)
корисних копалин
освітній рівень вища освіта
(назва освітнього рівня)
кваліфікація 2147.1 Гірничий інженер, дослідник
(код і назва кваліфікації)
на тему: Планування та розробка вугільної шахти при розгляді відповідного
повністю механізованого видобутку, для забезпечення щоденного
видобутку у 30.000 тон корисного матеріалу з двох вугільних пластів

Виконавець:

студент II курсу, групи 184М-16-11-ГФ

Кайсим О. Р.
(підпис) (прізвище та ініціали)

Керівники	Посада, прізвище, ініціали	Оцінка	Підпис
проекту	проф. Ковалевська І. А.		
розділів:	проф. Ковалевська І. А.		
Оглядовий	проф. Ковалевська І. А.		
Технологічний	проф. Ковалевська І. А.		
Аналітично-дослідницький	проф. Ковалевська І. А.		
Комп'ютерне моделювання	проф. Ковалевська І. А.		
Рецензент	проф. Ковалевська І. А.		
Нормоконтроль	проф. Ковалевська І. А.		

Дніпропетровськ
2018

Ministry of Education and Science of Ukraine State
Higher Educational Institution "National Mining
University"

APPROVED:
Head of Department
of Underground Mining
(full name)
Prof. Bondarenko V. I.
(signature) (surname, initials)

« _____ » _____ 2018

**ASSIGNMENT
for Master's work**

speciality 8.05030101 Mining and extraction
(code and name of speciality)
of mineral resources

student 184m-16-11-GF Kaisym O. R.
(group) (surname and initials)

Topic of the thesis Planning and development of a hard coal mine under
the consideration of an applicable completely mechanized extraction to ensure
a daily extraction of 30.000 tons of usable material out of two coal beds

1 FOUNDATIONS FOR WORK PERFORMANCE

The order of Rector of State University "NMU" from _____ № _____

2 OBJECTIVE AND INPUT DATA FOR THE WORK

Object of research The deposit of a hard coal

Subject of research The selection and application of fully mechanized extraction of the
material and general project of mining works

Purpose The design of a hard coal mine and development of the galleries network to obtain a
workable conditions and application of respective technique to achieve the daily production rate

Initial data for work Mining and geological characteristics of the coal seams;
layout of the massif; geological location of the mine field

3 EXPECTED RESEARCH RESULTS

Scientific novelty Planning of mining works and choice of cutting method for the particular
mining and geological conditions of south-west German region coal seams

Practical value Guarantee of planned production rate of the mine; proposed technique for
extraction; option of a workable scheme of recovery

4 REQUIREMENTS FOR RESULTS OF WORK PERFORMANCE

The results of the qualification work should be presented as general concept for realization, with a reasoning of applied solutions, based on computer modelling of the deposit and provided data

5 STAGES OF WORK PERFORMANCE

Name of work stages	Deadline
Data processing and literature review	01.10.2017
Research of technologies	14.10.2017
Comparison of methods and applying for given conditions	10.11.2017
Practical part. Calculations and simulations	28.11.2017
Selection and rationalizations of appropriate equipment	02.12.2017
Formalization of the work with an observance of the scientific writing. Preparation of results	14.01.2018

6 IMPLEMENTATION OF RESULTS AND EFFICIENCY

Economic effect from the realization of the project may be investigated during concretization of project parameters choice and their application in real conditions

Social effect from the realization of results of the work is continuous supply of the usable material, extracted by mechanized winning and high safety level and conditions of the work for labor throughout absence of manual work

7 ADDITIONAL REQUIREMENTS

Thesis must be designed according to GOST 3008 - 95 "Dokumentatsiya. Zvity u sferi nauky i tehniky. Struktura i pravyla oformlennya" and in accordance with methodical recommendations and requirements for the performance of degree works by students of the education and qualification level of Master from specialty 8.05030101 Deposits Development and mineral resources extract (underground mining)

Assignment issued

(signature)

prof. Kovalevska I. A.

(sumame, initials)

Assignment took to perform

(signature)

stud. Kaisym O. R.

(sumame, initials)

Issue date of assignment: 01.10.2017

Deadline for the thesis submission to examination commission: 21.01.2018

ABSTRACT

Topic: Planning and development of a hard coal mine under the consideration of an applicable completely mechanized extraction to ensure a daily extraction of 30.000 tons of usable material out of two coal beds.

Master thesis work: 78 pages, 36 Figures, 24 Tables, 19 references.

The object of research is the hard coal deposit.

The subject of research is the approach of mechanized recovery of the material out of two coal beds.

Purpose of the work is the design of a hard coal mine and developing a network of galleries to obtain workable conditions and application of appropriate technique for achieving planned production rate of usable material.

Research methods: overview of scientific research; overview of mine experiences; analyze of coal mining methods; computer modeling of the deposit, based on the side and front views of the deposit.

Results of underground investigations and application of various winning machines for particular conditions of seam laying are presented. Options of mine field opening are considered and the most satisfying one was chosen. Recovery of panels and direction of their movement are chosen accordingly to geological characteristics of the mine field and taking into account experiences of panel design approach used by countries such as Australia, U.S.A. and Germany. During a panel design, entry system and barrier pillar sizes were established with a help of different principles, based on sizes of panel and depth of occurrence. The transport inside the mine consist of a net of conveyors, linked between, on purpose to ensure the continuous transportation of the rock mass.

MINE, COAL, DESIGN, DEPOSIT, PLANNING, LONGWALL, FACE, GALLERY, PLOW, SHEARER LOADER, PILLAR, SEAM, MODELLING, MINE FIELD, STRESS-STRAIN STATE, PANEL, PRODUCTIVITY, CUTTING SEQUENCE, OPENING OF THE MINE FIELD

Міністерство освіти і науки України
Державний вищий навчальний заклад
"Національний гірничий університет"

ЗАТВЕРДЖЕНО:
завідувач кафедри
підземної розробки родовищ
(повна назва)

_____ проф. Бондаренко В. І.
(підпис) (прізвище, ініціали)

« _____ » _____ 2018 року

ЗАВДАННЯ
на виконання кваліфікаційної роботи магістра

спеціальності 8.05030101 Розробка родовищ та видобування
(код і назва спеціальності)
корисних копалин

студенту 184м-16-11-ГФ Кайсим О. Р.
(група) (прізвище та ініціали)

Тема дипломної роботи Планування та розробка вугільної шахти при розгляді
відповідного повністю механізованого видобутку, для забезпечення
щоденного видобутку у 30,000 тон корисного матеріалу з двох вугільних пластів

1 ПІДСТАВИ ДЛЯ ПРОВЕДЕННЯ РОБОТИ

Наказ ректора Державного ВНЗ "НГУ" від _____ № _____

2 МЕТА ТА ВИХІДНІ ДАНІ ДЛЯ ПРОВЕДЕННЯ РОБІТ

Об'єкт досліджень Родовище кам'яного вугілля

Предмет досліджень Вибір та застосування системи повністю механізованого
видобутку корисної копалини і загальний проект гірничих робіт

Мета Дизайн вугільної шахти та розробка мережі виробок для забезпечення пригідних
умов для роботи та застосування відповідної техніки для досягнення планового
добового видобутку

Вихідні дані для проведення роботи Гірничо-геологічна характеристика
вугільних пластів; розріз гірничого масиву; географічне розташування шахтного поля

3 ОЧІКУВАНІ НАУКОВІ РЕЗУЛЬТАТИ

Наукова новизна Планування гірничих робіт та вибір ведення очисних робіт при
конкретних гірничо-геологічних умовах вугільних пластів південно-західного регіону
Німеччини

Практична цінність Забезпечення планової добової продуктивності шахти; підбір гірничої
техніки для видобутку; запропонована робоча схема видобутку

4 ВИМОГИ ДО РЕЗУЛЬТАТІВ ВИКОНАННЯ РОБОТИ

Результати виконаної роботи представити як загальноможливий концепт для реалізації, з обґрунтуванням прийнятих рішень, на базі комп'ютерного моделювання родовища та на підставі забезпечених даних

5 ЕТАПИ ВИКОНАННЯ РОБОТИ

Найменування етапів робіт	Термін виконання
Обробка отриманих даних та робота з літературою	01.10.2017
Пошук доступних технологій	14.10.2017
Порівняння методів видобутку та їх застосування при конкретних гірничо-геологічних умовах	10.11.2017
Практична частина. Розрахунки та моделювання	28.11.2017
Вибір та обґрунтування відповідної техніки	02.12.2017
Оформлення роботи з дотриманням наукового стилю написання. Представлення результатів	14.01.2018

6 РЕАЛІЗАЦІЯ РЕЗУЛЬТАТІВ ТА ЕФЕКТИВНІСТЬ

Економічний ефект від реалізації результатів роботи може бути досліджений при конкретизації вибору параметрів проекту та їх впровадженні у реальні умови

Соціальний ефект реалізація проекту забезпечить безперервний постачання вугілля, добутого завдяки механізованого видобутку та високого рівня безпеки та умов праці робітників через відсутність людської праці

7 ДОДАТКОВІ ВИМОГИ

Дипломна робота має бути оформлена відповідно до ДСТУ 3008 – 95 "Документація. Звіти у сфері науки і техніки. Структура і правила оформлення", а також згідно з методичними рекомендаціями та вимогами до виконання дипломних робіт студентами освітньо-кваліфікаційного рівня магістра з спеціальності 8.05030101 Розробка родовищ та видобування корисних копалин (підземним способом)

Завдання видав

(підпис)

проф. Ковалевська А. І.

(прізвище, ініціали)

Завдання прийняв до виконання

(підпис)

студ. Кайсим О. Р.

(прізвище, ініціали)

Дата видачі завдання: 01.10.2017

Термін подання дипломної роботи до ЕК: 21.01.2018

РЕФЕРАТ

Тема: Планування та розробка вугільної шахти при розгляді відповідного повністю механізованого видобутку, для забезпечення щоденного видобутку у

30.000 тон корисного матеріалу з двох вугільних пластів.

Дипломна робота магістра: 78 с., 36 рис., 24 табл., 19 джерел. **Об'єкт досліджень** – родовище кам'яного вугілля.

Предмет досліджень – вибір та застосування системи механізованого видобутку корисної копалини і загальний проект гірничих робіт.

Метою роботи дизайн вугільної шахти та розробка мережі виробок для забезпечення пригідних умов для роботи та застосування відповідної техніки для досягнення планового добового видобутку.

Методи дослідження - огляд наукових досліджень; огляд досвіду шахт; аналіз способів видобутку вугілля; комп'ютерне моделювання родовища, що базується на фронтальному та боковому ескізах.

Представлені результати шахтних досліджень та застосування різних видобувних машин для конкретних умов залягання пластів. Було розглянуто підходи для відкриття шахтного поля і вибрано найбільш відповідні вимогам. Видобуток панелей та напрямок їхнього просування вибрано зважаючи на геологічні характеристики шахтного поля та беручи до уваги досвід планування лав таких країн як Австралія, США та Німеччина. При проектуванні панелей, система входу та бар'єрний стовп були визначені за допомогою різних підходів, які базуються на розмірах виймальних панелей та глибині залягання. Внутрішньо шахтний транспорт складається з системи сполучених між собою конвеєрів різного типу для безперервного транспортування гірничої маси.

ШАХТА, ВУГІЛЛЯ, ПРОЕКТУВАННЯ, РОДОВИЩЕ, ПЛАНУВАННЯ, ЛАВА, ЗАБІЙ, ВИРОБКА, СТРУГ, КОМБАЙН, СТОВП,

ПЛАСТ, МОДЕЛЮВАННЯ, ШАХТНЕ ПОЛЕ, НАПРУЖЕНО-
ДЕФОРМОВАНІЙ СТАН, ПАНЕЛЬ, ПРОДУКТИВНІСТЬ,
ПОСЛІДОВНІСТЬ ВИДОБУТКУ, ВІДКРИТТЯ ШАХТНОГО ПОЛЯ

Declaration of Authorship

"I hereby declare that this thesis is entirely my own work except where otherwise indicated. The presence of quoted or paraphrased material has been clearly signaled and all sources have been referred. The thesis has not been submitted for a degree at any other institution and has not been published yet."

Gratitude

In order to get a master's degree of mining a long and hard path has been gone. First of all, I am much obliged to my parents – Kaisym R. M. and Kaisym O. D. for bringing up, moral and financial support, love and education. Also, I want to say thanks to my younger sister, Kaisym O.R., which helps me to feel things easier and for her ability to defuse any situation.

I am acknowledged to my supervisor Prof. Dr.-Ing. Helmut Mischo, Chair for underground mining methods, for an opportunity to do this work and for his guidance, comments and suggestions. Moreover, I am very grateful to mentors which convinced me of proper way, indicated on mistakes and for own suggestions during my writing – Dipl. Ing. Sebastian Becker and M. Sc. Julia Herhold.

I would like to show appreciation for highly organized program of the National Mining University by Prof. Bondarenko V.I. and Prof. Kowalevskaya I.A.

I thanks for the good monitoring and organization aspects of program to Cherep A. Y., for promoting understanding of work process through excursions and practical experience.

I want to say thank you to my girlfriend Hryn A.P. for moral support and not let me to give up.

I show gratitude to my friends and colleges, which were going this path with me and for their thoughts, support and help.

Abstract

Coal as a fuel is the cheapest source, which takes minimal investments, for energy production. This fossil fuel provides 30% of global primary energy needs and takes share of 40% of the world's electricity production. Also it is using widely in steel production, which has a share of 70% of the world's. There are two views on the total proved reserves submitted by German Federal Institute for Geosciences and Natural Resources and by BP Statistical review of World Energy. The first one brings a amount of the proved reserves about 1052 bil. t., when the second one – 892 bil. t. If to take into considerations production rate which takes place nowadays it will give us more than 110 years of coal output. Total production, according to World Mining Data 2016, gave an output of nearly 8 bil. t. of the coal in 2015. The leading positions of the fuels production takes countries such China, United States, India and Russia.

From time to time, technology of coal winning is changing and with years the coal locates deeply below the surface what makes it challenging to extract. In these cases methods of open cast mining cannot be applied but the methods of underground mining takes advantage. Shaft sinking can already achieve depth of 4 km, but mostly these depths of deposit locations can be found in the gold mines. Technology of the hard coal extraction will lead to big depths of coal deposit in the future. Thereby, mine planning plays huge role of project's feasibility.

The task of this qualification work is to make a plan for a hard coal mine and develop the network of galleries to obtain workable conditions of extraction and to apply appropriate technique for achieving planned production rate of usable material.

Content

Declaration of Authorship	10
Gratitude.....	11
Abstract	12
Content.....	13
1 General information.....	15
1.1 Production of the coal	15
1.2 Coal mining in Germany.....	18
1.3 Characteristics of the deposit.....	20
1.3.1 Overview of the deposit	20
1.3.2 Belonging to the region	25
1.3.3 Waters	25
1.3.4 Soils	26
1.3.5 Importance of the land in the mine allotment	27
2 Division of the mine field	29
3 Opening of the mine field.....	31
4 Panel design.....	33
4.1 Entry system	35
4.2 Barrier pillar.....	36
5 Cutting sequence	39
5.1 Bi-directional cutting method.....	39
5.2 Uni-directional cutting method.....	40
6 Cutting direction	42
6.1 Longwall advance mining.....	42
6.2 Retreat longwall mining.....	42
7 Face equipment.....	44
7.1 Winning equipment	44
7.1.1 Shearer loader Eickhoff SI750	45
7.1.2 Shearer loader Joy 7LS2A.....	46
7.1.3 Shearer loader Caterpillar EL2000	48
7.2 Armored face conveyor	51
7.3 Mechanized support.....	53
8 Transportations inside the mine	54

Planning and development of a hard coal mine under the consideration of an applicable completely mechanized extraction to ensure a daily extraction of 30.000 tons of usable material out of two coal beds

9 Calculations.....	56
9.1 Production calculations for the shearer.....	56
9.2 Calculations of the different cutting sequences.....	58
9.2.1 Bi-di cutting cycle.....	59
9.2.2 Uni-di full-face cutting cycle.....	62
9.2.3 Uni-di half-face cutting cycle.....	65
9.2.4 Choose of cutting sequence.....	67
9.2.5 Panel belt conveyor.....	68
9.3 Matching calculations for the shearer and AFC.....	71
9.4 Reserves estimation.....	75
10 Conclusion.....	77
Bibliography.....	79
List of figures.....	81
List of tables.....	83
List of abbreviations.....	84
Annex.....	85

1 General information

The long time ago, when industry of coal extraction born, a production of hard coal was built on a simple way of scooping material by the shovel and loading it into cars. The huge step in an evolution of the technology gives an opportunity to built highly mechanized, safe and profitable ways in coal extraction nowadays.

Over the years, approach to get underground are dictated by the deposit location. In case when coal reserves are found at big depths below the surface, the method to get an access to mineral is shaft sinking. By this vertical galleries operations such a transporting of material and people, ventilation, supplies are used. If the deposit lay not at a great depth, slope shaft could be used to open the mine field. An another one method of sinking is to drive an adit in the hill, if conditions are suitable. In this case the opening gallery will be horizontal.

Selection of the approaches are influenced by geography and geology. However, the entry to the mine have an impact on economic conditions. Sinking of the vertical galleries require much more investments than for an opening of the coal seam located in the contour of a hill. During the planning of an entry to mine geological conditions of a coal seam must be taken into account.

After stage of getting access to the seam, most popular methods of coal extraction are used. There are room-and-pillar method and longwall mining method. Historically, the first one was widely used, but longwall mining was simpler to understand and to initiate. Through past decades, revolution in mining equipment allows to use this methods of mining with a new efficiency. It was marked, that longwall mining has been replacing the room-and-pillar method due to new technologies. Longwall method can be successfully used at great depths, and probably, it will allow to extract the coal seams in the future, when only deep deposits will be left. (cp. Dix, Keith, 1988)

Planning and development of an underground mine is always unique e.g. conditions vary over the space. Mine design moves through 3 main stages – conceptual, preliminary and final design. The most important issue for the design is the geology. Any small failure can grow in the future in huge losses of production rate and how consequence in a great losses of money.

1.1 Production of the coal

Almost all of the coal reserves(more than 80%) are located in only 10 countries. These countries are: USA, Russia, China, Australia, India, Germany, Ukraine, Kazakhstan, Colombia and Canada. On the top of the wealth of this mineral is United States with a share of more than quarter of the proven coal reserves. The biggest consumer of coal in the world – China, lays on the third place of the top.

According to the WMD 2016, production of the coal(steam coal, coking coal, lignite) around the world stays on the almost constant level from 2010 to 2014.

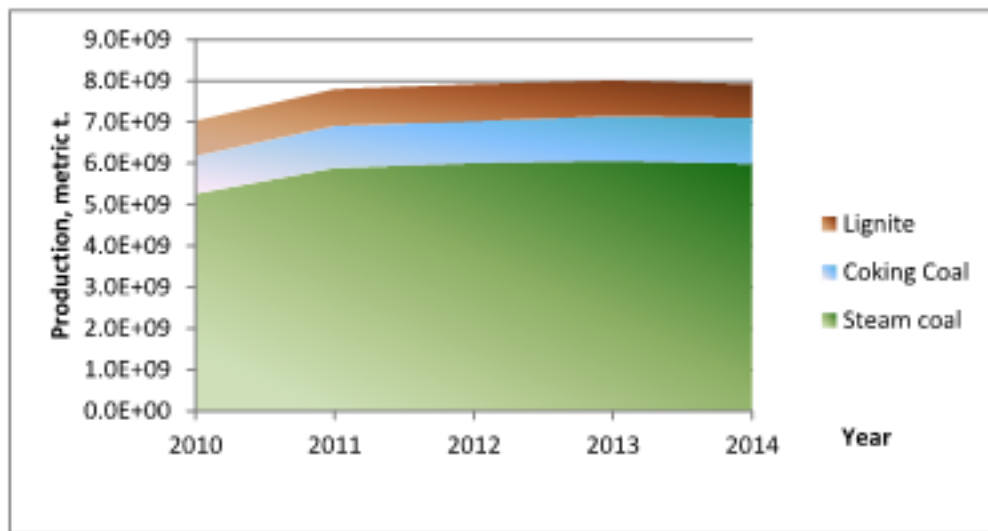

Figure 1. Coal production worldwide

If to take a look deeply on the production rate of major countries, it can be noticed that the only 6 countries worldwide are the main producers of the coal. The share of these countries in a world production is almost 85%, Some of this countries are also the mentioned as riches countries in the coal reserves sense.

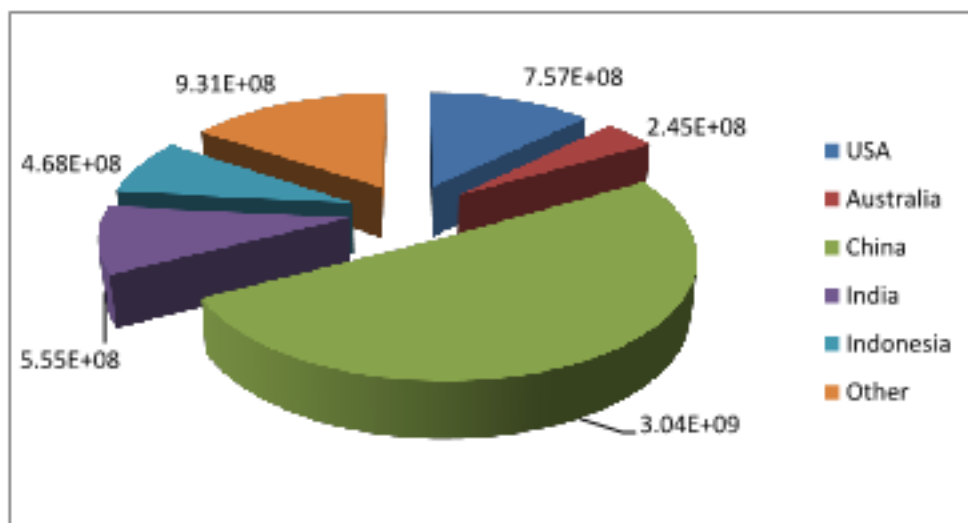

Figure 2. Steam coal production in 2014, metr. t

Steam coal(thermal coal) is used in power generation. Nearly to 40% of electric power around the world are generated by the thermal power stations. The half of the world coal production is coming from China.

Coking coal is an important element of steel production. The biggest producer is China as well. Coking coal has a low volatile matter content and high swelling index. The share of the leading producing countries is up to 90%.

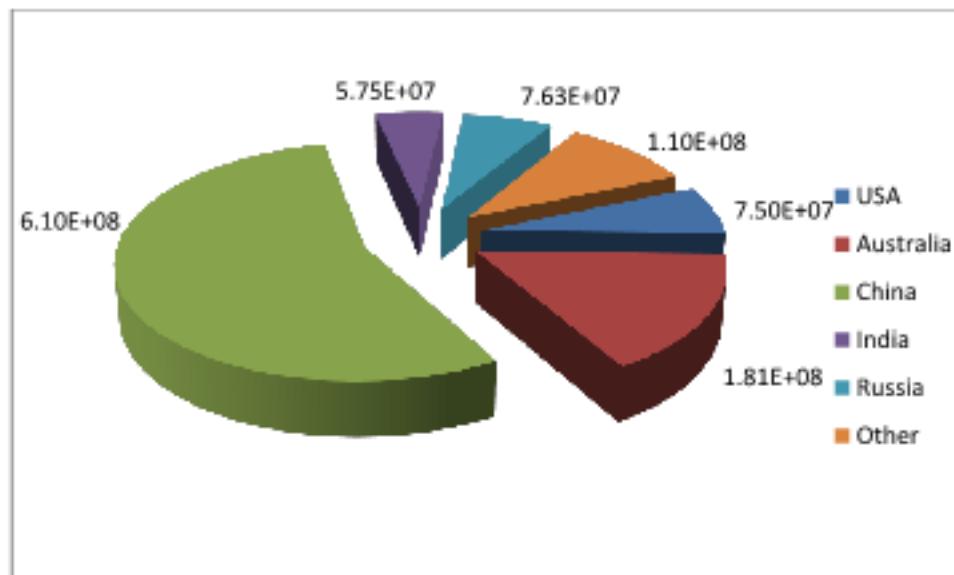

Figure 3. Coking coal production in 2014, metr. t

Usually, lignite can be extracted by the open cast method of mining e.g. the veins are located relatively close to the surface. Lignite is used in power generation industry. It has content of the carbon and density between peat and bituminous coal. The main producers make up to 65% of the world extraction. The biggest rate of extraction is given by Germany.

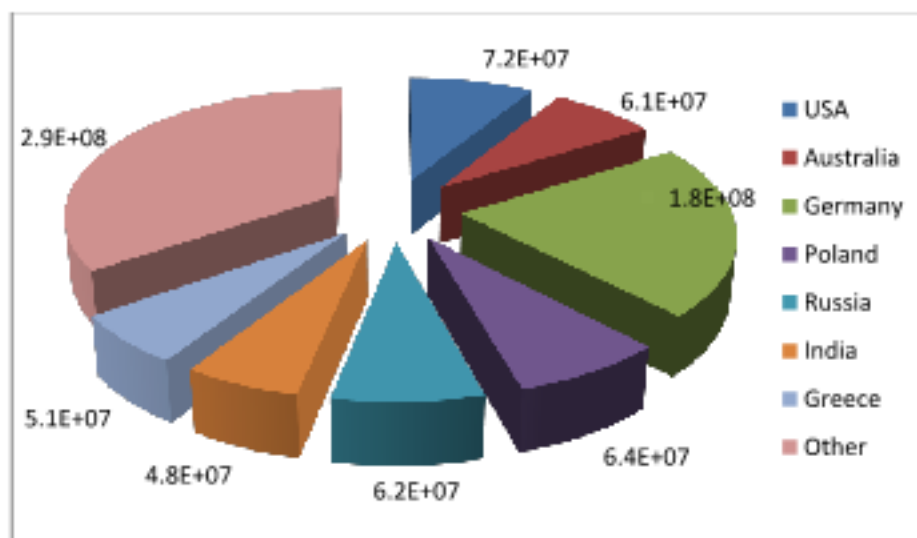

Figure 4. Lignite production in 2014, metr. t

How it was mentioned before, the most famous methods of underground coal extraction are longwall mining and room-and-pillar mining. Sequence of operations and technology were sharpened over the years. Among the major producers of the coal are countries with these methods of mining applied for certain conditions.

1.2 Coal mining in Germany

Annual output of different coal types made about 186 mio. short t. in 2014. The almost all number of an output makes up lignite with a share of 95%, and the only 5% - steam and coking coal. (cp. Reich, Schatz, Zsak, 2016)

There are 6 major districts of the hard-coal mining in Germany. There are: Ibbenbürener Revier, Ruhrrevier, Aachener Revier, Saarrevier, Sächsisches Revier, Bayrisches Pechkohlen Revier.

The total surface of mining over the regions cumulate more than 600 km², with number of 900 shafts, 10s of 1000s km of galleries, adits and gateroads. (cp. Mischo, 2015)

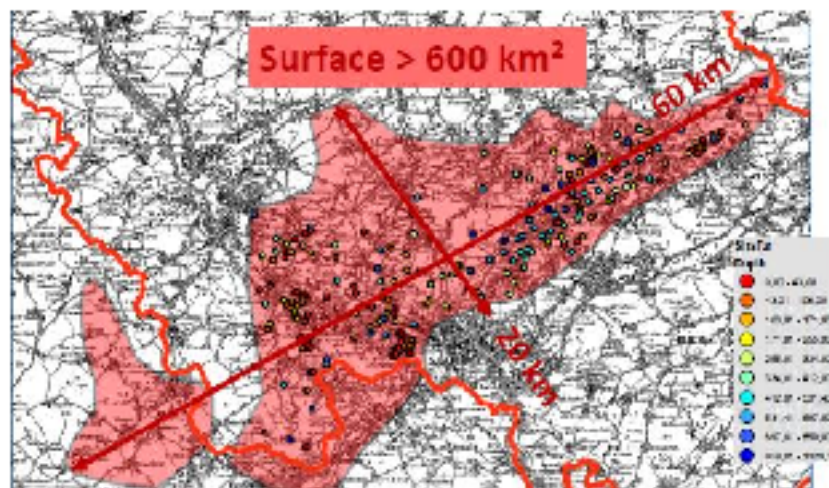



Figure 6. Ibbenbüren mine

The second one is Prosper-Haniel Mine with an 3 mio. t. output per year. It is employ more than 4000 people and has a maximum depth of about 1200m. Mining of the coal is done by longwall mining method which employ shearers and ploughs. The german mining conglomerate RAG owns the mine. The location of the mine is near to Düsseldorf city, in North Rhine-Wesphalia as well. (cp. Mischo, 2015)



Figure 7. Prosper-Haniel mine

The last two mines will shut down by 2018, according to a plan approved in 2007 by Angela Merkel's government. The phase out doesn't affect Germany's brown coal

surface mines. The agreement looked forward to ending the subsidies received by the underground mining sector.

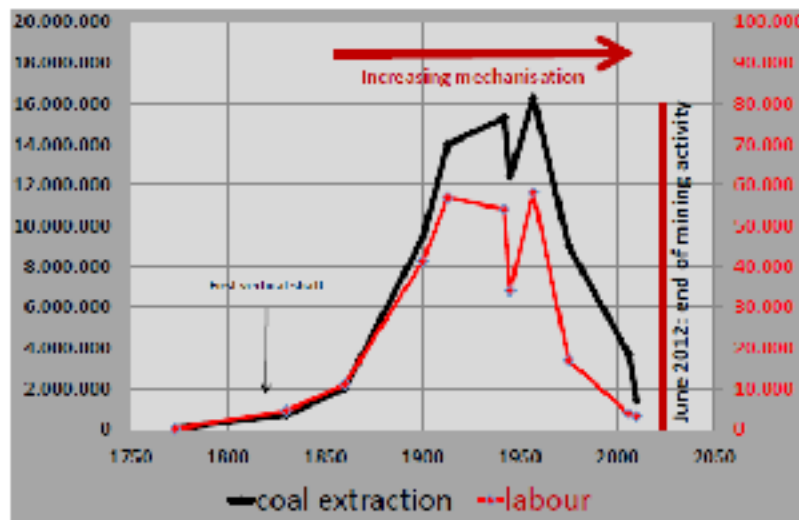

Figure 8. Changes of production and labour force in Saar mine

Before the mine “Saar” was closed, coal extraction was decreasing since 1960, when the mine was on the peak of production and was giving about 16 mio. t. of the usable material. On the graphic above, it can be noticed how the output was decreasing with an increasing of mechanization. Labor force was suffering from the closing the mine. The agreement eliminates approximately 35,000 mining jobs.

1.3 Characteristics of the deposit

1.3.1 Overview of the deposit

The total area, allocated for the mine field make up to 275 km².

The geographical coordinates which represent boundaries of the considered field are:

№	Coordinates	
	North latitude	East longitude
1	49° 19' 34.1"	6° 55' 27.0"
2	49° 33' 54.4"	6° 59' 04.0"
3	49° 34' 53.7"	6° 51' 18.3"
4	49° 20' 32.0"	6° 47' 19.1"

Table 1. Coordinates of a mine allotment

Based on the data of coordinates for given mine field, the schematic figure of the area, allocated for the mine was drawn. The boundaries of the mine field represent beginning and the end of the coal seams which are appropriate conditions to mine.

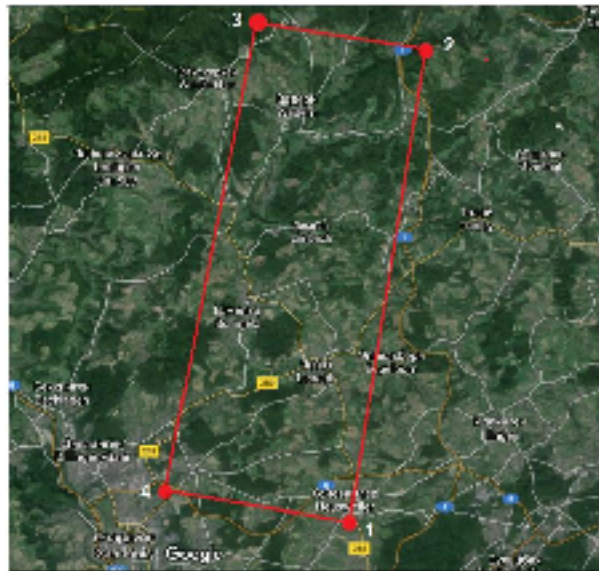

Figure 9. Boundaries of a mine allotment

However, if to look at the cuts which are presented below, it's clearly shown, that the laying conditions of the coal seam are inappropriate for underground coal mining. There are too much discontinuities and the angle of the dip is too steep. For this are most appropriate method for extracting will be open cast mining. In addition, the coal seams can be exposed on the surface, what gives the sense for an open cast mining application.

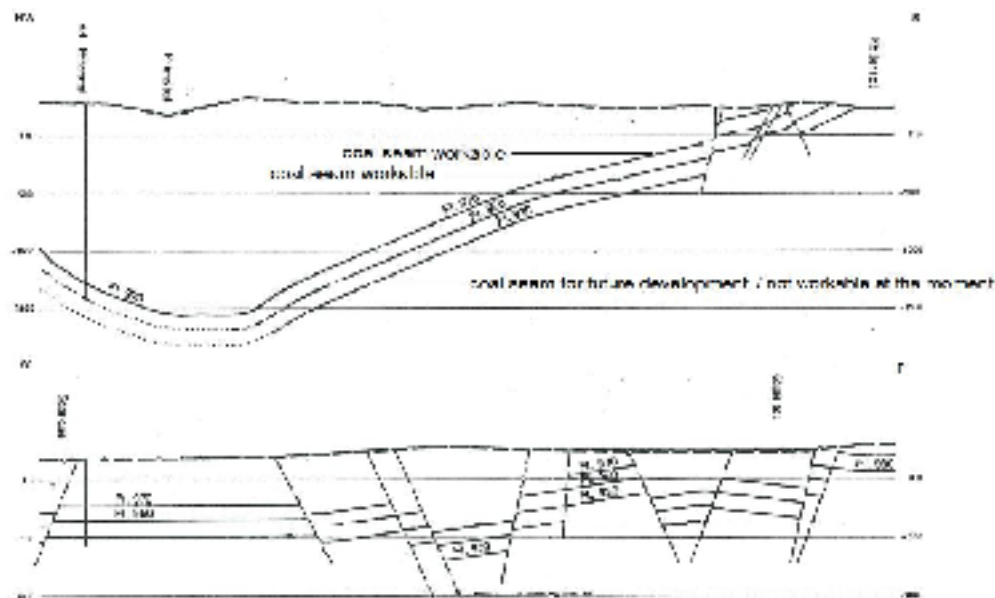

Figure 10. Position of coal seams in the strata

Based on the figure above, the 3D model was created in AutoCad to picture the stratigraphic characteristics of the seams:

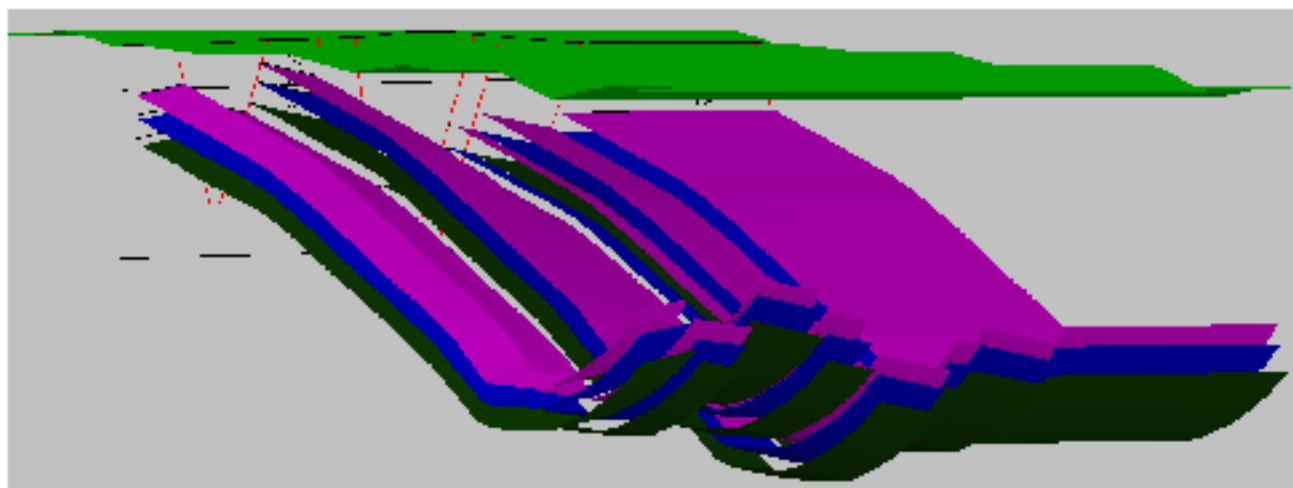

Figure 11. 3D model of the coal seams

Area which is not suitable for an underground mining is about 54km². The coordinates of the area which is not appropriate for an underground extraction are:

№	Coordinates	
	North latitude	East longitude
1	49° 19' 34.1"	6° 55' 27.0"
2	49° 22' 14.8"	6° 56' 18.1"
3	49° 23' 23.7"	6° 48' 20.2"
4	49° 20' 32.0"	6° 47' 19.1"

Table 2. Corrected coordinates of the mine allotment №1

This area will not be considered further. It is located in the bottom part of the whole mine field. The length of the mine field on a dip – approximately 5,4km, on a strike – 10 km. The area is relatively big, and can be mined with a several single pits, due to inhabited locality.

As a result, space for considerations in this master thesis is about 216km². The length of the mine field on a dip is 21.6km, on a strike – 10km. Schematic view of the land's allotment, which holds the interested coal seams, is given below.

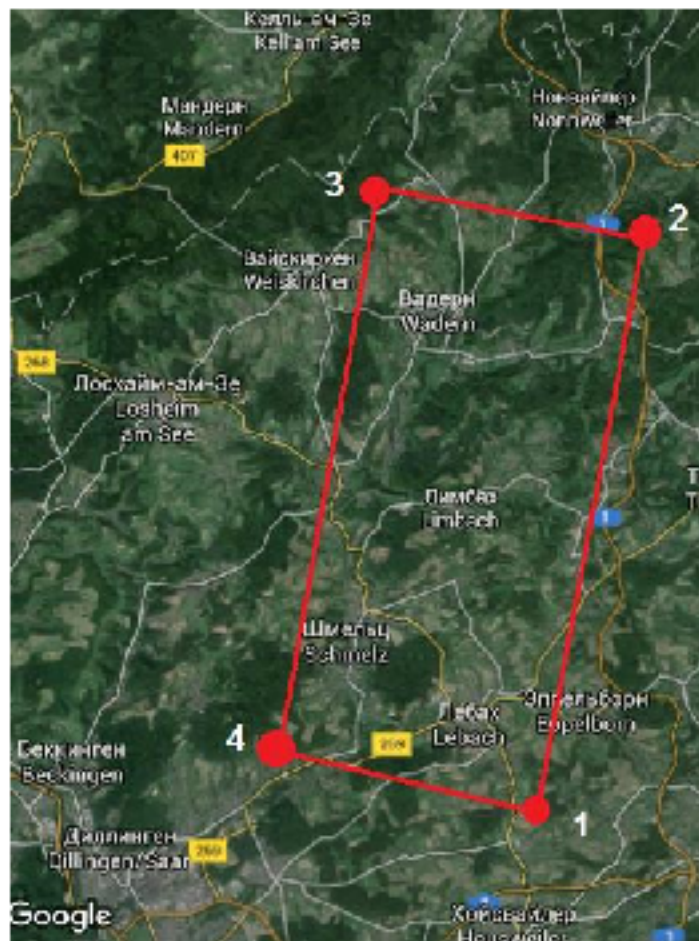

Figure 12. Corrected boundaries of the mine allotment №1

Depth of the coal seams varies from 300 to 1500m. The extraction of coal mining in deep coal mines is not under consideration nowadays, since capital investments don't meet the feasibility of projects. Coal reserves are investigated to 1500m depth, where the coal seams lay with a dip angle of 35° . In this case, mining of the seams will be challenging, e.g. the location of them is on a border of coal field what brings difficult conditions for a proper ventilation and transportation. The decision to leave the part of coal bed with an angle of a dip of 35° was made. In the future, after the other coal seams will be mined, the possibility to extract the left behind coal seams could appear. For this purpose, the blind shaft can be driven through the seams to get an access to them.

The final picture of mine allotment will look like:

Name of the seam	Structure of the seam	Density, t/m ³	Relative methane-bearing capacity, m ³ /t	Ash content, %	Calorific value, kcal
Fl. 970	complicated	1,35	7-9	7-9%	>7000
Fl. 950	complicated	1,35	7-9	7-9%	>7000

Table 5. Characteristics of the workable coal seams

The deposit is located in the west part of Germany in Saar region, of the same name of the river runs through the region. Area of the region is about 2,600km². The state capital of Saar region is – Saarbrücken. The population of Saar region is more than 1 mil. people(as of 2012).

1.3.2 Belonging to the region

The deposit is located in the west part of Germany in Saar region, of the same name of the river which runs through the region. Area of the region is about 2,600km². The state capital of Saar region is – Saarbrücken. The population of Saar region is more than 1 mil. people(as of 2012).

The state borders: France to the south and west, Luxembourg to the west and Rheinland-Pfalz to the north and east.

Saarland is very rich for forests, because of it, it has a forestry landscape. Agriculture products include grain, dairy products and livestock.

Industries which take place in the Saar region are: automotive industries, engineering, steel production and mining.

The space for the mine allotment contains inhabited towns. There are Lebach, in the southeast part of mine allotment, Schmelz, in the southwest part, Limbach in the center and Wadern in the northwest part.

1.3.3 Waters

There are 9 rivers which flows through the Saar region. There are: Saar, Glan, Rohrbach, Prims, Würzbach, Löster, Theel, Bos and Ill.

The region was named after the river "Saar". The length of the Saar is about 250m, where half of it is located in Germany, and the another half – in France. The river goes through the Saar's coal bed.

Through the mine allotment the river Prims runs from the north to south through the city Schmelz. The total length of the river is 91km. The height of the source is 500m, of the collar – 183m.

In spite of the surface waters, the huge importance in the underground mining is to know structure of the massif and the groundwater which is located in cracks, spaces in soil, sand and rock. It moves slowly through the rock layers calls aquifers. The figure below shows zones of main aquifers in the Saar region.

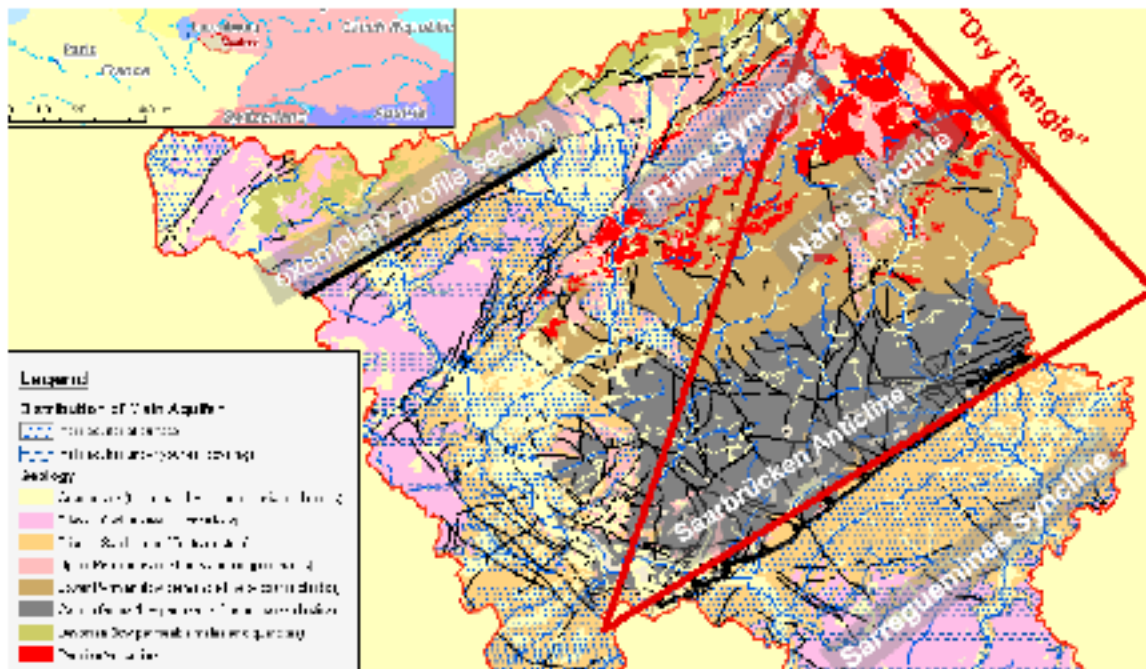

Figure 14. Geology and hydrogeology of the Saar region

Constant recharge of the ground waters by penetrations of precipitations and surface waters makes the ground water a renewable resource.

1.3.4 Soils

The Saar region is under influence of heavy industry atmospheric depositions. The geology of the area is represented by sandstone and limestone.. Natural soils in the sandstone region are mainly Eutric/Dystric Fluvisols and Cambisols. In the limestone region natural soils are mainly Rendzina, Eutric Cambisols and Calcic Cambisols. (cp. Fetzer)

Most of the soils were devoted to settling areas, as e.g. buildings and roads, industrial production, recreation sites, however, large areas were still used for plant growth in open spaces, forests or cultivated lands.

1.3.5 Importance of the land in the mine allotment

At EU level, nature and biodiversity are protected by several laws. The EU has been committed to the protection of nature since the adoption of the Birds Directive in April 1979. It provides comprehensive protection to all wild bird species naturally occurring in the Union.

The Habitats Directive was adopted in 1992 to help maintain biodiversity. It protects over 1000 animals and plant species and over 200 types of habitat. It also established the EU-wide Natura 2000 network of protected areas.

More recently, new legislation has been developed. In 1999, the EU reinforced the role of zoos in the conservation of biodiversity and, in the wake of the EU Biodiversity Strategy to 2020, committed to protect native biodiversity and ecosystem services against invasive alien species.

The Habitats Directive ensures the conservation of a wide range of rare, threatened or endemic animal and plant species. Some 200 rare and characteristic habitat types are also targeted for conservation in their own right.

The area of mine allotment has inside the areas of "Natura 2000" network of sites with habitats directive sites and birds directive sites, nationally designed areas with a protected landscapes and habitat/species management area. Over 1000 animal and plant species, as well as 200 habitat types, listed in the directive's annexes are protected in various ways. In the mine field, according to Annex IV species(over 400, including many annex II species): a strict protection regime must be applied across their entire natural range within the EU, both within and outside Natura 2000 sites.

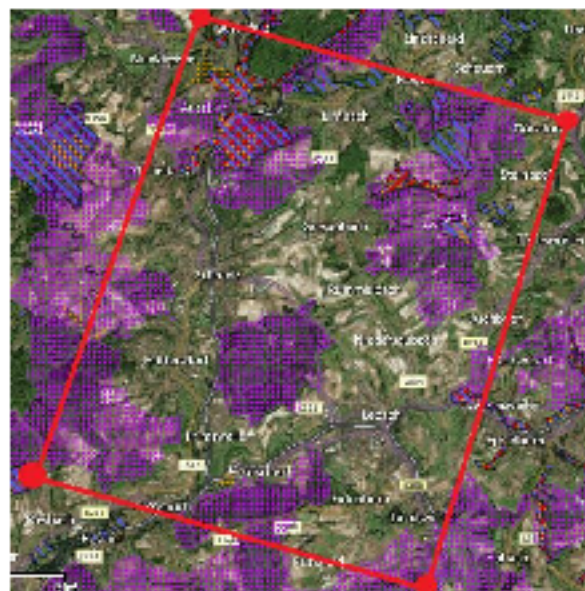

Figure 15. Protective areas inside the mine allotment

The area for a mine development is presented with the next allocated sites: the sites of community importance, special areas of conservation for the habitats directive sites are colored in a blue on the map; the special protection areas for the birds directive sites are painted in a red color; protected landscape is painted in a violet color; habitat species management area is colored in a orange color.

Taking into account the importance of protective areas in the given mine allotment, the necessity of reclamation may appear. Also, the works in the mine should not be prohibited to the secured sites. The protective sites as well as location of the cities have an influence on the location of main opening galleries such as shafts.

2 Division of the mine field

The division of the mine field apart is carried out in order to make a systematic, consistent process in reserves developing of the mine field, the concentration of extraction and preparation operations, to ensure supply of the air to the all faces and ease of maintenance of mining equipment. Ultimately, it should help to reduce the amount of galleries and maintenance requirements for it, to improve the safety of operations and decrease the cost of opening and preparation for the mine field.

When the dimensions of a mine field are significant (up to 18 km), it should be divided into blocks with the sizes of the strike 2-4 km, and of the dip up to 2,2 km. (cp. Bondarenko, 2002) A lower size of the block corresponds to a greater discharge of methane in the mine. The number of layers and developed distance between the seams is not limited, by the manual. Depending on the angle of incidence of layers, the seams can be mined along the strike or the dip. The number of blocks which have being extracted simultaneously is determined by the design capacity of the mine and the production rate of the block.

Block is a part of the mine field, characterized by independent system of mining operations. During the winning of the flat and incline seams, block is the part of a mine field, which is opened by down- and up-cast shafts, which are used for the self-sectioned ventilation of its workings, tripping the people, equipment, materials. Usually, there are several blocks within the mine field. For all the blocks a shaft for mined rock transportation is built in the centre of a mine field. The blocks are connected between themselves by a mutual transport route, using which, the coal is transported to the shaft and to the surface. When a mine field is divided into blocks, one or several transport horizons may be employed.

The need for dividing the mine field into blocks caused by the increased volume of a methane in the mine workings, as well as the fact that for a considerable length and branching of the galleries create additional problems with their ventilation, temperature control inside a mine, support of workings and utilization of an equipment.

The splitting into blocks accelerates the building of a mine, because it allows the drifting of the opening and preparation galleries in the same time in several blocks, what provides independent ventilation of each block, what brings the possibility to increase a production rate of the faces and their number, simplifying the scheme of an underground transport and reduces the cost of maintaining the workings by reducing their length. The main disadvantages of the dividing the mine field in the blocks are: significant amount of major openings with a corresponding increase in a volume of their drifting; dispersion of surface sites for shafts and increase the total area of land allotments; the complexity of the operation of the long main developments in the transport horizon.

The obtained area, which will be used as a mine field, will be divided into two equal sections, in the middle of a mine field. The names for these two fields will be

“North” and “South” with a respect to mine fields location on a map. Dimensions of the mine fields on the strike are equal and are about 10 km, and the dip – 7 km.

The division of the mine field into blocks is as follows:

- along the strike, mine field is divided into 3 different sizes segments. Selecting segments boundaries adopted on the basis of the complexity of the structure of the coal seams and discontinuities. Cut #1 accommodates a bed series from 1 to 3. According to the projection length of seams along the strike to the surface, it will be 3,23 km for the seam Fl. 970, and 3,256 km – Fl. 950. Cut #2 houses the bed series from 4 to 7. According to the projection length of the seams to the surface, it will be 3,498 km for Fl. 970 and 3,377 km for Fl. 950 coal seam. Cut #3 holds the very last bed series – 8. In the projection it will be 2,945 km for the seam Fl. 970 and 3,04 km for the seam Fl. 950.
- along the dip, mine fields “North” and “South” are divided into 2 parts of 3.5 km each. The structure of the deposit does not show any discontinuities along the dip.

The total number of blocks in the mine field – 12. Area of the blocks:

- for Fl. 970 formation:
 - №1, 4, 7, 10 – 11,305 km²;
 - №2, 5, 8, 11 – 12,243 km²;
 - №3, 6, 9, 12 – 10,3075 km²;
- for Fl. 950 formation:
 - №1, 4, 7, 10 – 11,305 km²;
 - №2, 5, 8, 11 – 11,8195 km²;
 - №3, 6, 9, 12 – 10,64 km².

The total area of the mine field – 135,422 km².

3 Opening of the mine field

System of the opening galleries provides an access from the surface to a mineral, determines the general direction of a transportation to the surface, ventilation of the mine, effectiveness and safety of mine operations.

Opening a mine field should be accomplished by at least two major galleries that have an access to the surface (shafts, adits). One of them is the main, which serves for a transport goal, the other one – auxiliary, for an additional exit from the mine.

To get an access to the deposit by the drilling shafts can be appropriate for a case when one seam with a vertical laying must be opened, for a seam with a horizontal and flat laying also. Opening of the seams with flat laying may be done by flat shaft. Opening of the mine field with an adit is relevant for a mountain locality, with the drifting across the horizontal or flat seam.

Depends from geological conditions and economical aspects, the main openings can be located in the center, on the wings or in the upper or lower parts of mine field

Based on the recommendations of the mine field division into the blocks, opening of the mine field should be carried out for each block individually and to provide an own ventilation. These recommendations are applicable for mines with seams which are not as deep bending. For the given parameters and the same amount of blocks (12), as well as in situ formation up to 1500 m, the equipment of the two ventilation shafts for each block is impractical and requiring significant investments, what in a future, most likely, will lead to a drop in a overall profit to 0.

Based on a great scale mine field along the dip and strike, the project production rate and the depth of the mining, the decision on the opening of a mine field by 3 vertical shafts was adopted.

The shaft №1, which is a transport and downcast shaft, will be driven in the centre of the mine field. The location of the shaft is in centre, due to considerations of transport and ventilation factors. During the extraction of the blocks in the mine field "North" and "South", haulage of the rock mass will be carried out through the incline tunnels. Approximate depth of the shaft – 789 m, include a sump.

The shaft №2, upcast and for the lowering of people and cargo, is located in a centre of the mine field "South" with a goal for providing ventilation for the entire mine field. Depth of the shaft – 518 m include a sump.

The shaft №3, second upcast shaft for the lowering of people and cargo, is located in a centre of the mine field "North" for providing ventilation for the whole mine field. The depth of the shaft is 1110 m.

The location of the shafts is chosen accordingly to the EU protective sites and do not affect the habitats in this zones.

The method of the mine field opening by the 3 shafts has own disadvantages such as a significant length of transport tunnels and costs of maintaining for them, required high power ventilation machines for high-quality ventilation and for the keeping required level of oxygen in the distant work faces, scattered of the shafts, what brings necessity more land allotment. The advantage of this method are relatively small amount of opening for a huge mine field, simple scheme of ventilation and transportation, concentration of the works.

4 Panel design

Preparation of mineral reserves in the mine field is executed by a system, which is characterized by a certain order of development workings, is linked in a time and space. Opened stocks are divided into parts that are convenient for cutting within their field of excavation, set priorities for their preparation and testing, determine the order of mining operations.

Severances of the coal seams create 8 parts of the deposit with the different angles between the strike length and a surface.

The sequence of the bed series was taken from the point 1 to the direction of point 4. The length of the different bed series was measured from the cut and collected into the table. (see: Annex p. I).

The total length of the coal seams make up:

- for Fl. 970: on the strike – 8976m.; on the dip – 14050m;
- for Fl. 950: on the strike – 9072m; on the dip – 13930m;
- for Fl. 930: on the strike – 8697m; on the dip – 13810m.

The parts of the coal seams will be designed in a manner to create the panels which will be mined further with a longwall mining method. The panels should be as large as possible, to reduce the development ratio and the number of non-production days. The dimensions of the panel depend on the geomechanical conditions of the massif.

For the conditions of deposition, namely with an angle of the dip more than 18° , for seams which are hazardous due to methane emissions, based on a guidelines for the design of mines, storey method of preparation may be used. In this scheme, blocks of the mine field should be divided into storey with thoughts about face lengths. This scheme of preparation is the most simple. Based on the sizes of blocks which have gaps on the strike, the blocks will be divided into the storey, taking into account discontinuities of the seams and average lengths of the working faces.

In the highly-mechanized mines in USA, the average width of the panels is about 300 m, when its maximum length is up to 400 m. Length of the panels in average makes 2600m, maximum length – 4900 m. The current production equipment is able to produce up to 5 mil. t. of coal without need for major repairs. (cp. Peng, 2006)

Figure 15 shows the relative change in recovery from a 250m face up to a 500m face for ideal layouts (90° to the boundary), worst case layouts (45° to the boundary) and for the specific project. For the 90° case there is an incremental but diminishing increase in recovery for each face widening but for the 45° case, there is an accelerating decrease in recovery. (cp. RPM, 2014)

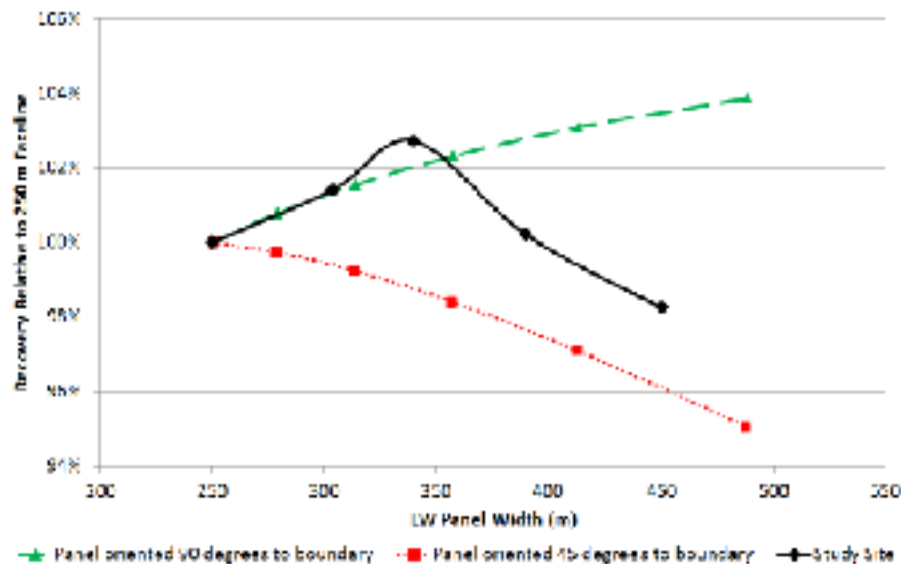

Figure 16. Dependency of a recovery rate from a panel width

For a 250m face virtually all of the production is achieved in about 50% of the cycle time during the main cut portions of the shear. By widening the face, the low output activity at both the maingate and tailgate ends remains constant and the high productivity portions of the cycle are extended. Productivity is therefore expected to increase in proportion to the face width.

Productivity modeling (using RPM's UG TALPACTM software) shows a 15% increase in output rate from 1,406 t/hr on a 250m face to 1,615 t/hr on a 390m face which equates to a potential output increase of 610,000 tpa. This is a highly favorable outcome that would make a significant impact on NPV if applied over the life of an operation. (cp. RPM, 2014)

So, the first working face may be on the edge of coal mine field, to prevent losses of coal and to start the extracting of the seams from the edges. The layout of the longwall panel is like:

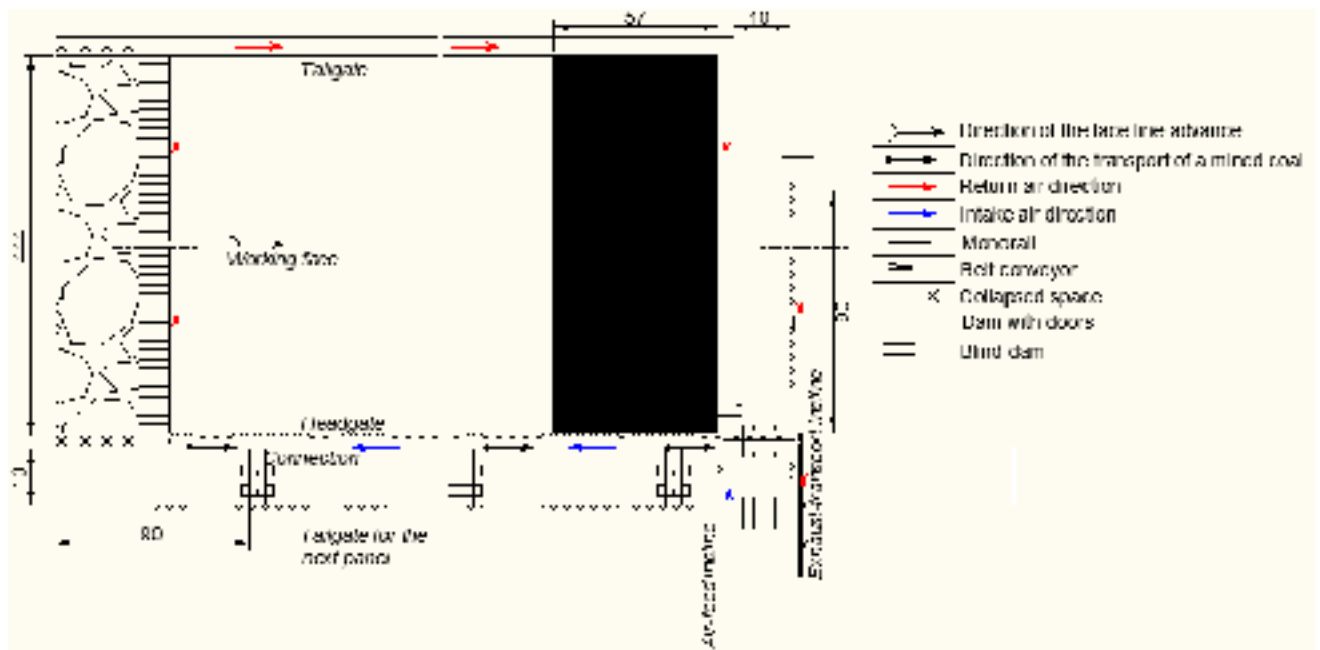

Figure 17. Layout of the panel

Full scheme with a view of all panels which will be mined from the coal seam Fl. 970 is shown. (see: Annex p. 5). The layout shows panels with a respect to their dimensions.

4.1 Entry system

Since the longwall method was introduced, to develop the panels continuous miners were employed. This is why the multiple-entry gateroad system is used. Experience shows that it is highly efficient method and it allows a fast longwall advancement rate. There are two-, three-, four- and five-entry and three- and four-entry combination systems. Through the practice of usage, amount of four-entry systems was decreasing since it requires more development footage than three-entry system. The two-entry system is not in compliance with the law, but upon request, MSHA has been approving it under special conditions. (cp. Peng, 2006)

To prevent coal bumps or sudden outbursts of large volume of coal, which are the consequences of large abutment pressures, the two-entry system is using yield pillar in rage of 8 to 10 m, which has been found helpful in reducing pillar bumps. According to MSHA, the only one rule for applying this system that the seam must be larger than 335 m deep. Data collected by MSHA shows that the added advantage of having a third entry in the tailgate is normally lost because of excessive road and floor instability. The first entry is used for the conveyor belt while the 2nd entry is the tailgate for the next panel. The entries are isolated between each other.

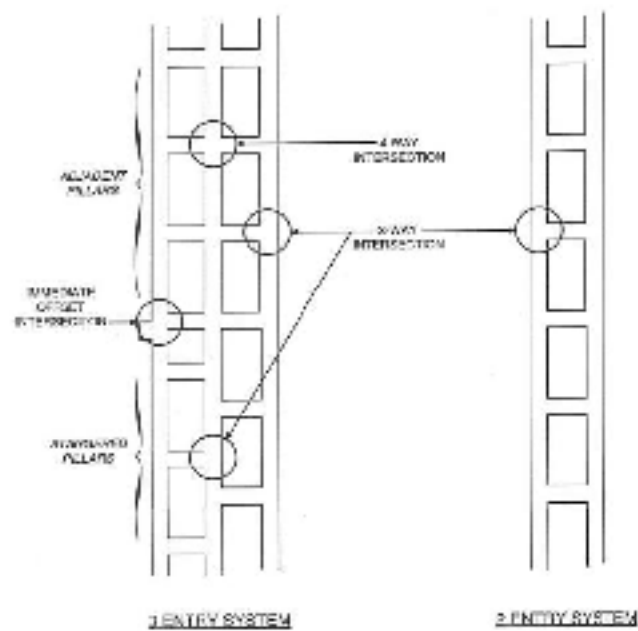

Figure 18. Entry systems

No gateroad system is appropriate for all geological conditions. The hoist rock and its geo-mechanical characteristics should be taken into consideration. From the figure above, it may be seen that the three entry system requires large amount of roof supporting instead of two-entry. There present 4 way intersections when in the two-entry only 3 way. The advantages of two-entry system are: minimizing gateroad span, reducing roof weighting on tailgate corner of face, reduces roof convergence and occurrence of falls. Pillar yield causes much of the abutment and overburden stresses to be transferred to the unmined coal block. (cp. Leo, Gillbride, 2007)

Strength of the pillars are affected by an in-situ coal strength, strength of laboratory cubical specimen may be calculated for specific cases.

The two entry system will be applied for the panel development in this work.

The one more important issue in panel design is a barrier pillar. It refers to that coal block left at the retreat mining end of the panel between the recovery room and the main entries. Based on the experience of US mines, in the past the width of it was around 150-180 m. However, in recent years numerical finite element modeling has been used and the width was reduced to 60-90 m in many cases. (cp. Peng, 2006)

4.2 Barrier pillar

The major issue in the economic sense is the design of barrier pillars between longwalls. The aim of the barrier pillars is to protect the gateroads from the effects of excessive deformation and to protect the surface from subsidence.

There are two major approaches in barrier pillar designing:

1) The ultimate strength approach. The assumptions are that a pillar will not fail if the applied load is equal to or less than the ultimate strength of the pillars. It assumes that the load-bearing capacity of a pillar is reduced to zero when its strength is exceeded. In this case, a global or average factor of safety is obtained for the entire pillar based on an average pillar is assumed to be constant across the entire pillar.

2) The progressive failure approach. This highlights the existence of micro-structural defects within the pillar and a non-uniform stress distribution in the pillar. In this approach, failure is initiated at the most critical point and propagates gradually to ultimate failure. Overall stability can be maintained despite local failure. Local safety factors are the primary aim of the stability analysis, and they are based on pillar strength and load at a given point. Hence, pillar strength and stress concentration across a pillar are available. This is probably a more realistic representation of the in situ condition.

Among the methods of defining the sizes of a barrier pillar, are methods which is not based on the geo-mechanical conditions of the overburden and characteristics of a coal seam, but on depth of occurrence, width of the panel and thickness of the seam. Because of poor amount of data, this method of an estimation are going to be used in this work. (cp. Majdi, Hassani and Cain, 1991)

1. Rule of thumb method.

This method was used by British coal operators which concluded that the width of the barrier pillar may be estimated as follow:

$$W_{bp} = \frac{H}{10} + 13,7, m;$$

where H – depth of cover, m.

2. The mine inspectors' method.

This approach was developed in Pennsylvania by the Mines inspectors' Commission established by the state government in 1927. It is presented by the equation:

$$W_{bp} = \frac{H}{10} + 4 * h + 6,1, m;$$

where h – extracted seam height, m.

3. The North American method.

This method takes into account extraction ratio of a seam and depth of cover. After shortening of equations, in the end it looks like:

$$W_{bp} = H * \frac{W_0}{2133,6 - H}, m;$$

where W_0 – panel width, m.

4. Dunn's rule

Mathias Dunn has established a rule for the size of coal pillars suitable for various depths. It's could be represented in the following form:

$$W_{bp} = \frac{H - 54,9}{6,1} + 4,6, m.$$

The calculations with a various cutting sequences will be employed for the panel with a 444 m face width further. Approximate depth of the place where the barrier pillar should be located is 370,5 m. The thickness of the seam is 3,34 m, seam Fl. 970. So, based on this data, the width of the barrier pillar may be estimated, using the approaches listed above.

Width of the panel, m	Thickness of the seam, m	Depth of the cover, m	Name of method	Width of the barrier pillar, m
444	3,34	370,5	Rule of thumb	50,75
			The mine inspector's method	56,51
			The North American method	93,3
			Dunn's rule	56,3

Table 6. Width of a barrier pillar

From the estimations, the almost same values are obtained in three cases. The highest value among them is 56,51. So, assume, the width of the barrier pillar will be 57 m.

The blocks will be divided into equal parts in a plane view with a widths of 437,5 m. The two-entry system is applied and barrier pillar of 57 m will be designed. Accordingly to minimum length of longwalls in USA, Australia and Germany, the bed series with 4 and 6 will not be extracted with a longwall system. Nevertheless, they can be extracted with a room-and-pillar method.

5 Cutting sequences

In general, there are two main cutting systems: uni-directional and bi-directional. The definitions of the systems come from cutting directions and cutting depth. In case of bi-di cutting sequence, a shearer loader cuts a coal seam in both directions, i.e. head-to-tail and tail-to-head and in each direction a full web-cutting depth is performed. In opposite, in uni-di, a shearer cuts the coal in one full web depth in the forward trip, while in the return trip it travels empty.

Most of the mines in Australia operate a uni-directional cutting sequence with a technique that provides simple operation, environmental benefits and minimal labor force. (cp. Mitchell, 2009)

However, the bi-directional cutting sequence has been seen as more productive, especially on longer faces. The main influence on the production has a haulage speed, but as a shearer power and haulage speeds are have increased, thicker seams are targeted and mine environmental issues require greater considerations, uni-directional cutting has become more competitive and in some cases can be more productive.

In US coal mining, the predominant method for cutting is bi-di, e.g. it is more productive for the wider panels.

5.1 Bi-directional cutting method

This system of extraction should be applied for the panels with big width, which are well maintained and operated. Constant dust control should be installed, because of continuous occurring of the dust. For a proper and effective use of this system, are recommended employing two shearer operators with a good knowledge of the system problems and faults.

Beneficial factors of the cutting may be:

- reduced demand on support system requirements(especially in thick seams);
- the ability to support the face better in poor conditions;
- greater benefits in thinner seams, where clearance under support is critical;
- snaking in both directions will keep face creep to a minimum.

The essence of the cutting sequence is depicted after Rutherford, 2001 and illustrated in a figure:

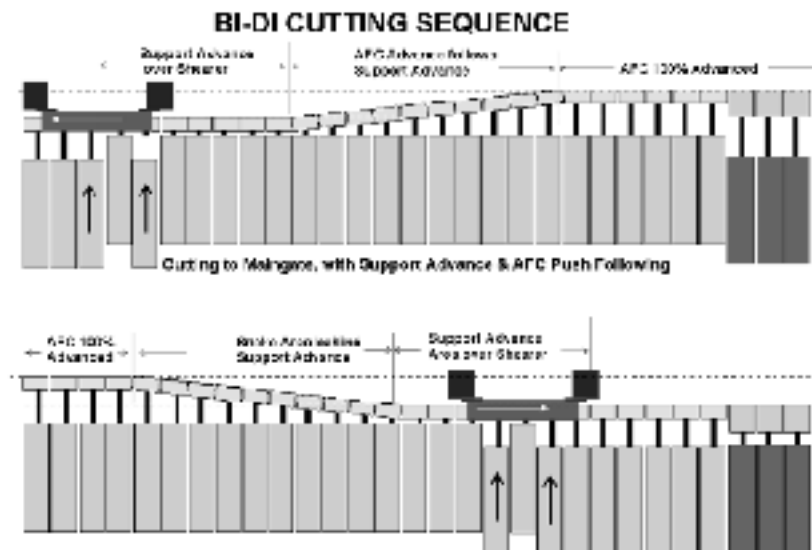

Figure 19. Bi-di cutting sequence

5.2 Uni-directional cutting method

There are many variations of this method. Basically, the shearer must pass across the face twice to extract the web. Because of principle, it removes the need to "shuffle" the shearer into the next web at each end of the face. The faster the shearer runs, brings necessity of proper support system. The need to have a faster haulage speed on the shearer comes from thoughts to reduce the "empty" run, what makes this method compatible with the bi-di cutting method.

Advantages of the method are:

- training requirements may be reduced because of simplicity of system;
- only one drum needs to be utilized;
- more environmentally desirable, because support advance is designed to be on the return side of the operator;
- loading on the equipment can be more easily regulated;
- greater flexibility in cutting cycle and support system operation.

The main point of the uni-di cutting sequence was presented after Ruthord, 2001. The traditional uni-di method applies a backward snake advance of the AFC.

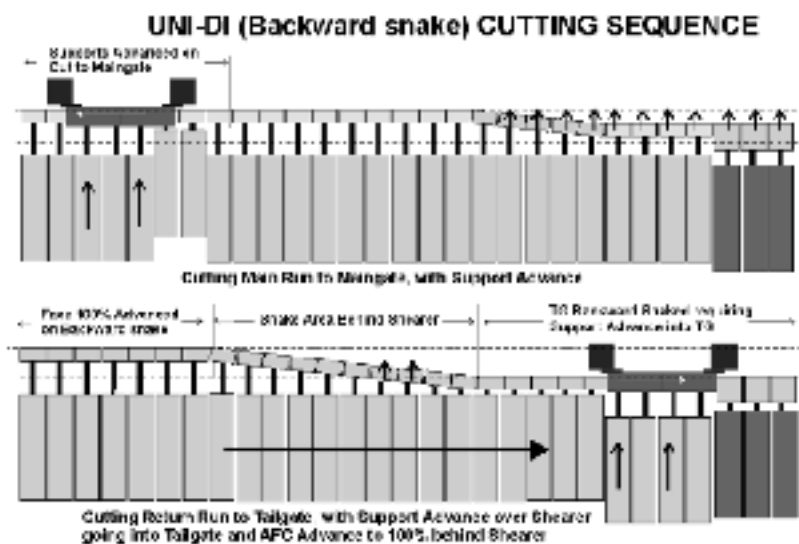

Figure 20. Uni-di backward snake cutting sequence

Among the variations of uni-directional cutting sequence, is the half-face cutting sequence. The essence of it is that the shearer cuts the only half of the face and the second half of the face it "shuffles" and cleans the bottom from the coal, loaded it into the AFC. The layout of the method was created.

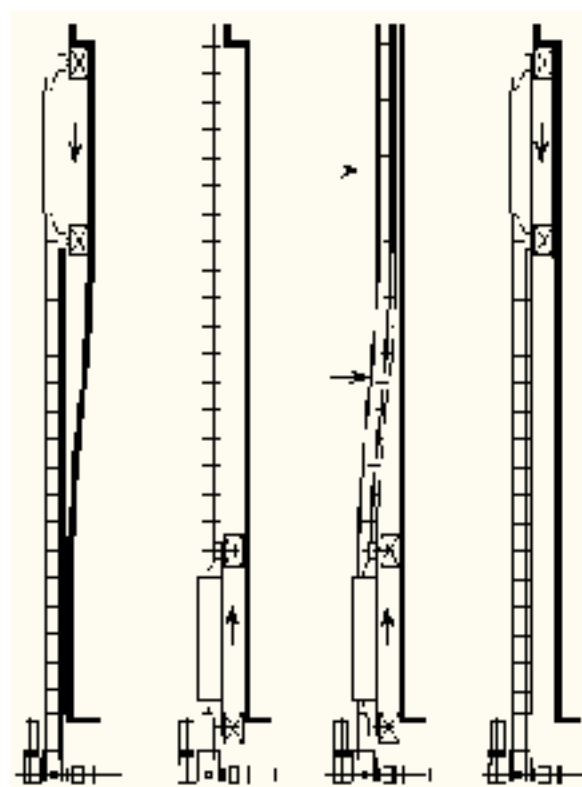

Figure 21. Uni-di half-face cutting sequence

6 Cutting direction

6.1 Longwall advance mining

Preparation of the panel, e.g. tunneling of a tailgate and a headgate, is going a little bit forward in front of a working face is the main point of the longwall advance mining. This method of the mining as a rule is used for a thin and medium coal seams on the various depths and angles of a dip.

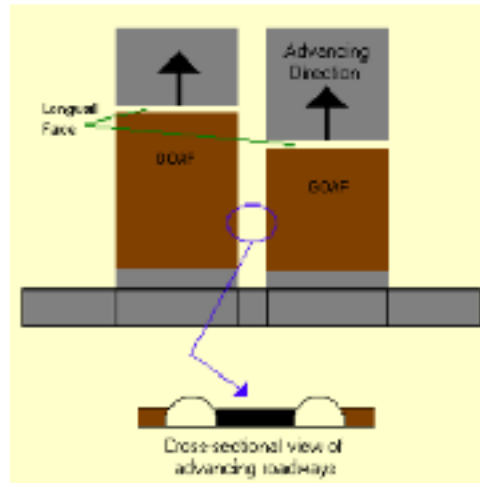

Figure 22. Longwall advance mining

Drifting pass ahead of the face and the galleries are supported until the panel will be mined out. Such opening tend to require a very heavy support systems(steel arches have often been used.

Advantages of the method are:

- fast beginning of works in faces;
- low first-time costs for a preparation of the panel;
- absence of long blind tunnels;
- possibility of applying various security methods for the tail- and headgate.

Disadvantages of the method are:

- high costs for a support of opening, because of influence of near-located working face;
- absence of an investigation of a seam by preparation galleries;
- mutual influence of the drifting and extraction operations.

6.2 Retreat longwall mining

The predominant method of longwal mining among the world is retreat system. Generally, by the tunneling of two main entries on a predetermined length, the entries

are connected and a rectangular longwall block is outlined. Then, the longwall equipment is installed and as mining goes toward to the mains, the entries are allowed to collapse behind the face line.

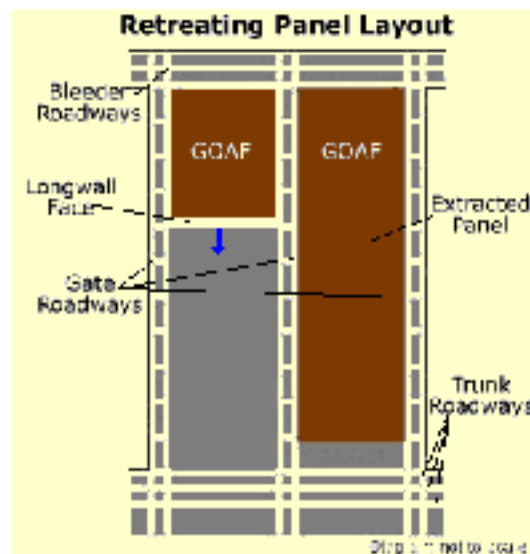

Figure 23. Retreat longwall mining

Advantages of the system are:

- good conditions of the transport opening and low costs for it's support;
- absence of a mutual influence of an extraction and drifting;
- detail investigation of the seam's geology;
- collapse of entries behind the face line;
- absence of a leakage of air current in a goaf;

Disadvantages of the system are:

- high volume of the drifting operations, before the coal can be mined;
- difficulties with a ventilation of long-length blind galleries;
- long-term support of main galleries.

So, taking into consideration all characteristics of the cutting directions, the choice of retreat mining of seams is more suitable for conditions described in this work, what will be applied further. The one more option, the advance mining may be employed, if the goal of fast bringing in an exploitation is needed.

7 Face equipment

7.1 Winning equipment

For the longwall coal mining machines such a plow and shearer is normally used. The use of a plow is appropriate for an extraction of thin and medium sized coal seams(not more than 2m). The application of a plow could be challenging because of structure of a deposit and possible inclusions. The difference in the hardness of layers in coal seam dictates operations of prior blasting. Also, an uneven weak soil prevents plow adoption.

With the development of engineering technologies, today winning machines provide high production capacity of the mines, mining coal seams of different thicknesses. The main parameter of the shearer selection is the ability of it to extract the exact thicknesses of a coal seam. During the process of choosing an equipment for the extraction, were considered various mining equipment construction companies and in the three major were highlighted – Joy Global Inc., Eickhoff Maschinefabrik GmbH and Caterpillar Inc.

Joy Global Inc. is a worldwide leader in high-productivity mining solutions. It is an American company that provides services for underground and surface operations. Joy manages facilities in Australia, South Africa, United Kingdom, China, USA with sales offices and service facilities in India, Poland and Russia. Joy products include: continuous miners, longwall shearers, powered roof support, armored face conveyors(AFC), shuttle cars, flexible conveyor trains, roof bolters, battery hauler, continuous haulage systems. This company was chosen because of its good market position, as well as good shown results in coal mining in USA and other countries, using it's extraction equipment.

Eickhoff is a global private company, which was established in 1864 in Bochum. The main focus of their activities is the production of machinery for the mining industry, including both the traditional methods of mining, surface and an underground as well as for renewable resources. Eickhoff is worldwide famous mining machines construction company. Its equipment was already used for winning of the coal in germany's mines.

Caterpillar Inc. is one of the leading corporations of the construction special machines in the world. It produces earth-digging transport technique, construction equipment, diesel engines, power plants(using natural and associated gas) and other products. The enterprise has more than 480 units located in 50 countries worldwide on 5 continents.

From the company's variety of the machines, one shearer from the each above listed company which is proper for the seam conditions was chosen. They are - Eickhoff SL 750, Joy 7LS2A and Caterpillar EL2000.

7.1.1 Shearer loader Eickhoff SI750

The Eickhoff SL 750 has been put into operation in US high-performance longwall systems for the first time in 2006, received a throughout positive feedback on its use. And also the subsequent worldwide installation of further machines of this type fulfilled all expectations by far. According to the unanimous opinion of the customers, higher production rates are achieved more economically when using the Eickhoff SL 750 shearer loader.

Accordingly to ICN(International Coal News), Xstrata's Oaky Creek North mine set several new Australian longwall records using Eickhoff SL 750 with EiControl automation. These included a one month longwall tonnage of about 1,5 million tones. Consol Energy's Bailey Mine completed its first 1,500 ft.(457,2 m) face longwall panel using an Eickhoff SL 750 shearer loader. A second 1,500 ft. face is currently being mined with Eickhoff SL 750 shearer. The longwall panels are about 12,000 ft.(3657,6 m) long.In 2011, the machine was cutting a hard coal 1,500 m below the surface at the Auguste Victoria mine in Germany.

The main advantage of the machine is its compactness and the power. Compared to the previous models of Eickhoff's shearers, the body of SL 750 is just slightly larger than the body of SL 300 but with the installed power bigger than has SL 500. The characteristics of the shearer were collected in the table.

Characteristic	Meaning
Cutting range, m	1,8 - 4,8
Voltage/frequency, V/Hz	3,300/500
Total installed power, kW	1,894
Cutting drum speed, rpm	32-50
Max. haulage speed, m/min	51
Total weight, t	70-80
Length, m	13,9 – 14,9
Width, m	2,7 – 3,4
Height, m	1,25 – 2,05
Cutting motors, kW	2x620
Winch motors, kW	2x120

Table 7. Main characteristics of the shearer loader Eickhoff SI750

The dimensions of the shearers parts are presented in the figure:

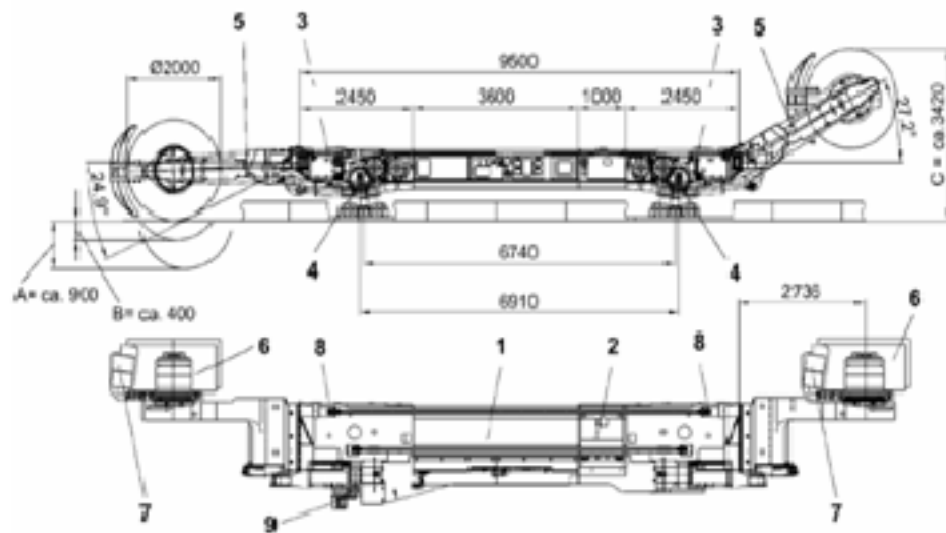

Figure 24. Layout of the shearer loader Eickhoff SI750. 1 – electro unit; 2 – ECP – Box; 3 – electric winch; 4 – wheel housing; 5 – cutting unit; 6 – cutting drum; 7 – plow blade; 8 – tie rod; 9 – line interception.

Shearer by side looks like:



Figure 25. Visual look of the shearer loader Eickhoff SI750.

7.1.2 Shearer loader Joy 7LS2A

Wide range for application of the 7LS2A shearer took place in the extraction with a longwall mining method in USA. It was used in mining states such as Illinois, Pennsylvania, North Virginia.

Information about utilization of the shearer has been collected. (see: Annex p.II) There are circumstances under which the shearer was used.

The body of the shearer consists of three high tensile steel fabrications bolted together to form a slim main section with no under-frame. This design provides maximum under-body clearance for material passage in a given seam thickness. The elimination of the under-frame also makes underground transportation easier.

The controller case, which forms the center section, contains the electric control system. The Joy design features gob-side access to the electrical controller section and motors which means that normal maintenance can be carried out in a safer working environment.

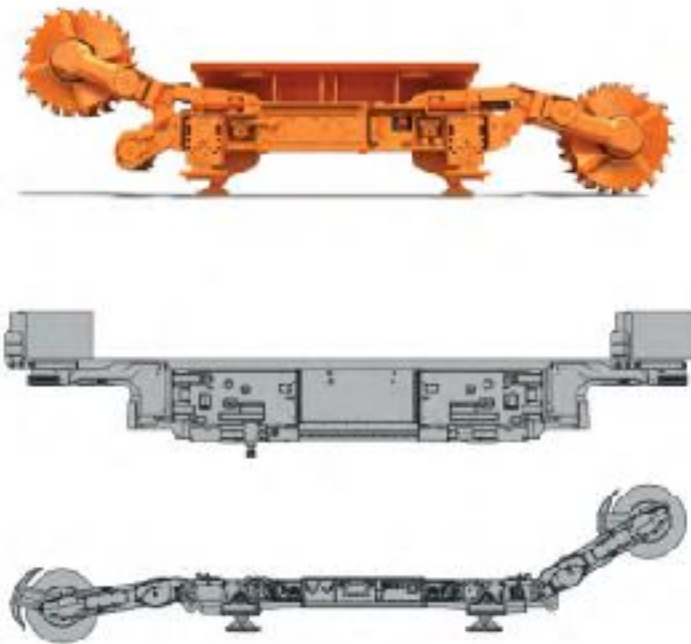

Figure 26. Layout of the shearer loader Joy 7LS2A

Two traction sections are bolted and doweled to each end of the controller case. The down-drives are bolted to the traction cases in an arrangement that permits the custom fitting of the shearer within the AFC and roof support envelope. A wide selection of Joy designed and manufactured down-drives can be fitted to the shearer to suit mining conditions and AFC selection. (cp. Joy Global)

High tensile steel ranging arm castings house the cutter motors and cutter gear cases. Ranging arm cylinders are made using technology from the JOY Powered Roof Support product line. These cylinders have double the pressure rating when compared to the industry norms. In-house manufacture of bit holders and cutter drums creates a higher degree of integration and allows engineers to better understand the drum's affect on machine performance. Gearing is designed and manufactured in its own factories using a proprietary process which contributes to maximum performance.

The main characteristics of the SL were collected and presented in the table:

Cutting height, m	Machine height, m	Machine weight, t	Frame thickness, mm	Haulage pull, kN	Maximum haulage speed, m/min	Pump motor, kW	Haulage motor, kW	Lump breaker motor, kW
1,6-3,5	1-1,3	59	520-590	800	33	2x11	2x80	55

Table 8. The main characteristics of the shearer loader Joy 7LS2A

There are ranging arms for the given SL, which could be applied based on the required conditions. The names and characteristics of the arms are shown in the table.

Name	Length of Ranging Arm, mm	Cutting Motor 50 Hz(max), kW	Minimum Drum Diameter, mm	Minimum Drum Width, mm	Drum Speed 60 Hz, rpm
J450A	2179	420	1350	880	44, 54, 65
J450D	2179	420	1450	940	44, 54, 65
J450E	2249	420	1450	880	55, 60, 66
J450F	2249	420	1450	880	66
J525E	2483	600	1550	960	47, 56, 61, 66
J525F	2483	675	1650	940	38, 45, 49, 53

Table 9. Characteristics of the arms for the shearer loader Joy 7LS2A

The J525E ranging arm will be applied, e.g. the drum width is the most biggest, what has an influence on the production rate, also the drum speed may be set to different amount of rotations, what brings the flexibility in a mining process.

7.1.3 Shearer loader Caterpillar EL2000

The worldwide famous company offers the EL2000 shearer loader, which meet the demands of the world's leading longwall operators in medium to high seam mining. According to the tests, made by the own company's center, the machine is highly reliable and it is suitable for the toughest mining conditions.

The ranging arm for the shearer is – RA750. It is designed and robustly tested, for longer service life.

- Transmission rating of 750 kW @ 37,4 RPM and above
- Maximum drum diameter of 2500 mm
- Choice of drum speeds
- Complete with 32 mm bore, through shaft PFF/PBF wet cutting
- Square drum hub(440 mm across flats)
- Maximum oil capacity of 28 L in high speed compartment and 30 L in the epicyclic
- Integral monitoring transducers

- Quillshaft transmission protection
- A robust cowl drive mechanism
- Online vibration monitoring with VibraGuard
- Available cutting motors: 500 kW, 620 kW and 750 kW @ 50 Hz.

The main characteristics of the winning machine are presented in a table:

Specifications	Machine @ 50Hz
Seam range, m	1,8 – 4,5
Typical machine length, mm	14155
Installed power, kW	up to 1780
Available cutting power, kW	2 x 500; 2 x 620; 2 x 750
Haulage system	AC Inverter drive
Haulage motor, kW	2 x 125
Haulage speed, m/min	Up to 30,1
Haulage pull, kN	Up to 945
Pump motor, kW	30
Body height, mm	600
Machine weight, t	70
Operating voltage, V	3300
Minimum pan width, mm	1032

Table 10. The main characteristics of the shearer loader CAT EL2000

The appropriate haulage unit for the shearer is HU125. Characteristics of the unit:

Total machine pull, kN	945,51
Speed at maximum pull, m/min	14,28
Maximum machine speed, m/min	28,56
Pull at Maximum speed, kN	472,75

Table 11. Characteristics of the haulage unit for the SL CAT EL2000

The relationship between haulage pull and speed is demonstrated in the figure.

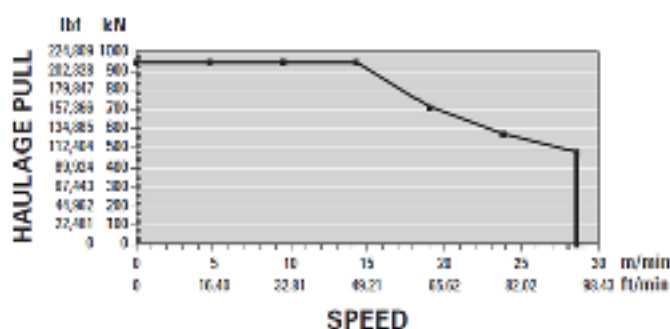

Figure 27. Haulage pull and speed of the machine

Characteristics of the haulage unit:

- Maximum power rating 125 kW
- Integral water cooling @ 9L/min

Planning and development of a hard coal mine under the consideration of an applicable completely mechanized extraction to ensure a daily extraction of 30.000 tons of usable material out of two coal beds

- Transmission reduction of 137:1
- Maximum oil capacity of 25 L
- Integral monitoring transducers
- Quillshaft transmission protection
- This unit has a haulage motor rating of 125 kW
- Available with Machine Position Encoder
- Available with Machine Parking Brake

Among machine configurations, there are 4 options which can be chosen to satisfy certain conditions of mining. The appropriate one for conditions in this work is "Mid-Low" machine configuration. It was applied, taking into account cutting heights and assuming normal shape coal seam.

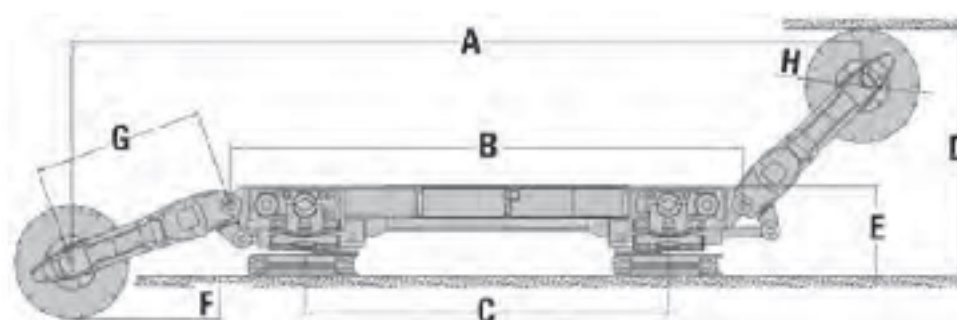

Figure 28. Front view of the shearer loader CAT EL2000

All dimensions marked on the machine sketch are approximate.

A Distance between Drums with Arms Horizontal, mm	14155
B Distance between Ranging Arm Hinge Points, mm	8525
C Distance between Trapping Shoe Centers, mm	6056
D Cutting Heights, mm	1900 – 4135
E Height to Top of Machine Main Body, mm	1495
F Shearer Drum Undercut of Floor, mm	718
G Ranging Arm Length(Hinge to Drum), mm	2815
H Diameter of Shearer Cutting Drum, mm	1900

Table 12. Front dimensions of the shearer loader CAT EL2000

Cross section of the machine looks like:

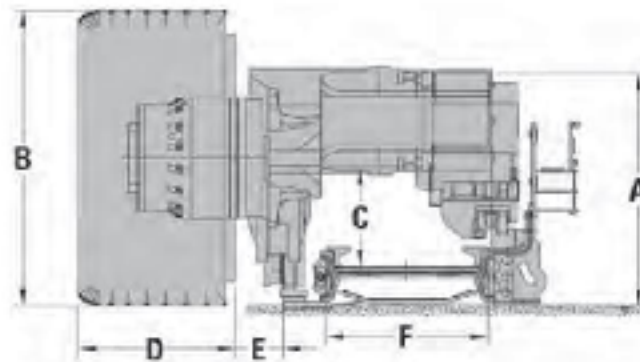

Figure 29. Side view of the shearer loader CAT EL2000

A Machine Height over Main Body, mm	1495
B Ranging Arm Cutting Drum Diameter, mm	1900
C Vertical Tunnel Clearance, mm	649
D Maximum Cutting Drum Overall Width, mm	1150
E Clearance from Drum to AFC Toeplate, mm	300
F AFC Pan Width, mm	1032 - 1342

Table 13. Side dimensions of the shearer loader CAT EL2000

7.2 Armored face conveyor

AFC is a continuous transport unit that carries bulk material on an unmoving pan with a help of chains which are armored with scrapers.

CAT offers AFC systems for use in longwalls of up to 500 m long. They are with an up to 3x1800 kW installed power and present capacities of up to 6200 tones/h. The AFCs is equipped with an intelligent CST drive system, rigid or automated tensional tail drive, haulage systems with either rack bar or chain. The company convinces consumers about high system availability, long service life and low operating costs.

Specifications of the AFC line pan PF4/1032:

Model	PF4/1032
Line Pan Width, mm	1032
Flightbar Width, mm	888
Deck Plate Thickness, mm	40
Profile Height, mm	284
Bottom Plate Thickness, mm	25
Dogbone Breaking Strength, kN	3000-3600
Dogbone Housing FoS, times	1,5
Shear Strength, kN	4000
Vertical Articulation, degree	Up to ± 6
Horizontal Articulation, degree	0,8 – 1,2
Chain Strands	AKB FI30x108 DKB 34x126 DKB 42x146
Conveying Capacity, m ²	0,46

Table 14. The main characteristics of the AFC CAT PF4/1032

The applied shearer dictates certain conditions for the AFC chose, to be exact, the range of AFC with a pan width from 1032 to 1342 mm. The conveyor with a minimum pan width of 1032 mm is checked and has show an appropriate capacity.

The data about dimensions of the given conveyor is shown in the figure and described in the table.

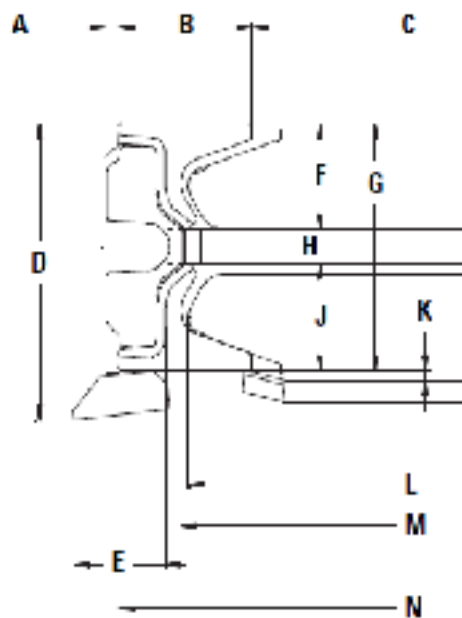

Model	PF4/1032
A	15
B	154
C	724
D	341
E	105
F	122
G	284
H	40
J	122
K	12
L	876
M	888
N	1032

Table 15. The main dimensions of the AFC CAT PF4/1032

Figure 30. Layout of the AFC CAT PF4/1032

The results of an application of the AFC show the next capacities with a speed range of up to 2 m/s.

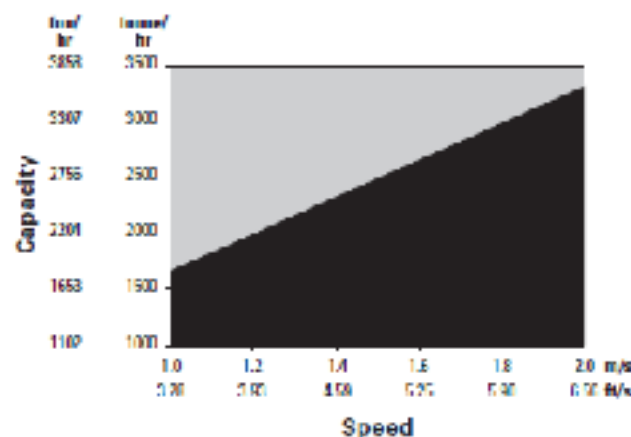

Figure 31. Capacity of the AFC CAT PF4/1032

From the figure may be noticed, that under the maximum speed of 2 m/s, the carrying capacity of the conveyor is around 3500 tonnes/h.

7.3 Mechanized support

Mechanized support is a support with a self-moving mechanism, which serves for the supporting of a side rock, to keep the working face in a workable manner. It provides mechanization of support processes and travel of an AFC.

The choice of an exact MS unit should be done based on the calculations and simulations of the rock mechanics above the working gallery. The two main parameters for it are lining resistance and support resistance. According to the data obtained from internal information of mine Saarberg Ens Dorf(1994), the support resistance of the mechanized support units was established on the 572 and 573 kN/m² and the lining resistance – 4675 and 5697 kN. Also, the operating range should be taking into account, e.g. thickness of the coal seam brings requirements for a height of longwall face, which should be supported.

Among the variety of equipment, RAG GmbH is offering a shearer roof support, which was already tested in the real extraction conditions and calculated after German or international standards. This support is constructed by already mentioned corporation – Joy. The figures with dimensions of the shield support have been presented. (see: Annex p. III and p. IV)

The main characteristics of the supports are collected in a table.

Name/Characteristic	Group A Joy	Group B Joy
Adjusting range, m	1,3 - 2,8	1,6 - 3,8
Hydraulic adjusting range with double lifting props, m	1,3 - 2,8	1,6 – 3,45 1,75 – 3,8
Operating range, min/max support, m	1,6 – 2,6	1,9 – 3,6
Cylinder diameter, m	0,38	0,37
Setting pressure, bar	0,38	0,37
Nominal pressure, bar	0,38	0,45
Support resistance, kN/m ²	ca. 700	ca. 750
Lining resistance, kN	ca. 7.500	ca 8.500
Force at the top of the cap, kN	ca. 2.100	ca. 2.000
Roof support weight, ca, t	23,5	28

Table 16. The main characteristics of the mechanized roof supports

Two types of an appropriate roof support were presented. Taking into account operating range of the shield supports, the support units Group A Joy could be used for support of the face during an extraction of the coal seam Fl. 950, when the Group B Joy – Fl. 970.

8 Transportation inside the mine

Transportation facilities of mines are used to carry the mined rock mass from faces to the surface and, in opposite way, if backfilling, support, equipment and materials are required. All these loads may be transported by various approaches: under a self-weight, by self-moving machines, scrapers, conveyors, carriages and winches.

To meet conditions of completely mechanized extraction, transportation should be continuous in time and ensure constant moving of the rock mass, to avoid delays during the mining. The most common method of continuous moving of bulk materials is the conveying of them.

Conveyor belts contain a belt which with a bulk material on it moves on idlers and serves simultaneously as a load-bearing and traction part.

The advantages of applying the conveyors are: high performance due to the continuity of the process of transportation, high reliability, technological suitability to work with an automatism of management and therefore low complexity of service and low risk to injure, ability of transportation materials on horizontal and incline tunnels, low laboriousness for shorting or extending the distance of transportation, especially for conveyor belts and convenience of junction with working and drifting faces.

The main characteristics of the conveyor belt and their strong sides are performance of 150 to 1500 t/h, and in some cases of more than 3000 t/h; length of 200 to 3000 m and more in one conveyor; an ability to work effectively with an angles of -16 to $+18^\circ$, and in some cases, with the applying of special measures – up to $\pm 25^\circ$.

Among the characteristics of bulk materials, which have influence on the design of conveyor, are: an angle of repose and an angle of surcharge.

The angle of repose of a material is the acute angle which the surface of a normal, freely formed pile makes to the horizontal. For typical common materials such as bituminous coal, stone, most ores, etc – $35-39^\circ$.

The angle of surcharge of a material is the angle to the horizontal which the surface of the material assumes while the material is at rest on a moving conveyor belt. This angle usually is 5 to 15 degrees less than the angle of repose, though in some materials it may be as much as 20 degrees less. For the bituminous coal is 25° .

The coal is lumpy size material, containing lumps over 1 cm, with average flowing, abrasive and mildly corrosive, accordingly to CEMA.

The belt widths are as follows: 0,45 m; 0,6 m; 0,75 m; 0,9 m; 1,05 m; 1,2 m; 1,35 m; 1,5 m; 1,8 m; 2,1 m; 2,4 m.

The width of the belts may be governed by the size of lumps to be handled. Belts must be wide enough so that any combination of prevailing lumps and finer material does not load the lumps too close to the edge of the conveyor belt.

The system of transportation of mined coal from the working face #1 in the mine is next:

- 1) the broken coal in a face is transported by an Armored Face Conveyor to a Tailgate, where it goes through a loader to a panel conveyor belt;
- 2) along the tailgate, the mineral moves on the conveyor belt to a junction with a transport-exhaust incline, where it unloads to an incline conveyor belt;
- 3) the coal moves on the incline conveyor belt to the main transport cross-cut, where unloads to the cross-cut conveyor belt;
- 4) the mineral is transported by the cross-cut conveyor belt passes by the intake shaft and unloads to the main roadway's conveyor belt;
- 5) the main roadway's conveyor belt carries the coal to the up-take transport shaft, where it is unloaded into a loading facility(bunker) and than is loaded to skips;
- 6) the skips move the rock mass to the surface and unloads it into a bunker.

Requirement for the conveyor, should be met is the productivity of the conveyor. From a handbook, the belt conveyor 2BT80U-01 satisfies the conditions of mining. To prove its capability for transportation the installed volume of material, calculations was done. The same type of calculations is similar for defining conveyor parameters in capital galleries and may be done in the same manner.

9 Calculations

9.1 Production calculations for the shearer

Theoretical performance is an amount of coal which is mined per time unit during an unstoppable winning. It can be calculated as follows (cp. Vasyuchkov Y.F.):

$$Q_{teor} = m * B * V_m * \gamma, \frac{m^3}{min};$$

where m – thickness of the seam, m;

B – width of web, m;

V_m – maximum speed of haulage which is allowable under given conditions, m/min;

γ – in-situ density of the coal, kg/m³.

Implacable haulage speed for given conditions may be obtained from the equation (cp. Kharchenko, Ovchinnikov, Sulaev, Gaidai, Russkich):

$$V_m = \frac{N_{set}}{60 * H_w * m * B * \gamma}, \frac{m}{min};$$

where N_{set} – constant power of the motors, kW. Usually it is in range from 0,7 to 0,9, depends on a type of motors, from the maximum power of motors.;

H_w – specific energy, energy required to produce and load unit weight of coal, kW-hr/t; The specific energy for coal ranges from 0,1 to 0,8 kW-hr/t, but mostly around 0,3-0,5 kW-hr/t.

Shearer	Theoretical performance, m ³ /min	Maximum haulage speed, m/min	
		Fl. 970	Fl.950
Eickhoff SL750	37,2	8,25	11,11
Joy 7LS2A	36	8,31	11,20
CAT EL2000	45	8,68	11,69

Table 17. Theoretical performance of the winning machines

From the table above, the conclusion about shearer loader choice can be done. Based on the calculations of theoretical performance, to satisfy highly-mechanized extraction of coal, the shearer Caterpillar EL2000 will be applied. All next calculations and assumptions will be done taking into consideration parameters and characteristics of this winning machine.

The haulage speed of the shearer is a crucial factor in the productivity calculations of a one face. It should match the speed of shields traveling to the mined area. In the face with a length of 444 m, next amount of the support units should be installed:

$$n_s = \frac{444}{1,615} = 274,9 \approx 275 \text{ units};$$

where 1,615 m – the width of the mechanized support, include 2x5 cm of free space between the support units.

The speed of roof supports moving should be defined. So, on the distance of 20 m, there are 13 units of mechanized supports. Speed of the roof support setting may be estimated:

For Fl. 970:

$$t_s = \frac{2,3}{13} \approx 11 \text{ sec};$$

For Fl. 950:

$$t_s = \frac{1,7}{13} \approx 8 \text{ sec};$$

And, on the distance of 424 m, there are 262 units. So,

For Fl. 970:

$$t_s = \frac{48,9}{262} \approx 12 \text{ sec};$$

For Fl. 950:

$$t_s = \frac{36,3}{262} \approx 9 \text{ sec};$$

So, as a result, the time for moving the roof support should be from 8 to 12 second for each unit, to fall into a pattern of mining. In the real conditions, the time of 12 seconds is not enough to move the support forward. According to this, the speed of the shearer haulage should be reduced to the speed of the support unit's travel.

The speed of travel the one support unit can be estimated.

$$V_s = \frac{b_s}{\sum t_s} \frac{m}{s};$$

where b_s - width of the shield, include free space between units, m;

$\sum t_s$ - time for the travel of support, min.

Time for the travel of support include in itself time for moving of the worker from one support to another(5 sec), time for clearing the shield(15 sec), time for unloading the support(10 sec), time for a move of the support(20 sec) and time for the shield moving apart(10 sec). So, in total, the time for the travel of support takes approximately 1 minute.

$$V_s = \frac{1,615}{1} = 1,615 \frac{m}{min};$$

The speed of the travel of support 1,6 m/min is applied.

9.2 Calculations of the different cutting sequences

Parameters for estimation

1. Mining and geological conditions.

Seam thickness:

Fl. 970 – 3,34 m; slice of hoist rock in the seam – 0,19;

Fl. 950 – 2,48 m; slice of the hoist rock in the seam – 0,25 m.

Seam depth: Fl. 970 – 314 – 1511 m; Fl. 950 – 456 – 1625 m;

Average density of coal:

in-situ 1,35 t/m³;

broken 1,04 t/m³(swelling ratio = 1,3)

Panel width: 444 m rib-to-rib

The panel is developed by a two-entry gateroad system.

2. Shearer parameters.

Model Caterpillar EL2000

Drum diameter: 1,9 m

Drum web: 1,15 m

Drum rotational speed: 45,2 rpm

Shearer weight: 70 tons

Maximum haulage speed: 30,1 m/min

3. Assumptions:

Production days for an underground mine is 360 days per year with a three nine-hour production shifts per day, or 20 shifts per week, on Sunday there is one maintenance shift.

Shift duration is 9 hour, taking into account 30 minutes travel to and from the face, what brings 8 hours of production time.

The utilization factor of the shearer is 80%.

9.2.1 Bi-di cutting cycle

Cycle of operations

1) Snaking length of the conveyor 20 m is required. Within distance of 20 m, the SL cuts the coal slice on a bottom of the face, and then runs empty from the headgate to the 20 m mark. The thickness of the slice – 1,44 m(thickness of the seam – drum diameter). The speed of the flitting is taken from calculations based on the support setting speed.

$$t_1 = \frac{20}{1,6} = 12,5 \text{ min};$$

2) Full speed coal cutting from HG to TG. Full seam coal cutting runs to the TG, the distance of the travel 444 m - 20 m = 424 m. Cutting speed is constant.

$$t_2 = \frac{424}{1,6} = 265 \text{ min};$$

3) Re-position of cowls and ranging arms to reverse cutting direction from TG to HG. Time for an operation – 1 minute is applied.

4) Cutting first the bottom coal between the two drums left in HG to TG run of task 2(1st wedge cut) and then full seam height coal cutting to the 20 m mark. Cutting length = 444 – 424 = 20 m. Cutting speed is constant.

$$t_4 = \frac{20}{1,6} = 12,5 \text{ min};$$

5) Re-position of cowls and ranging arms to reverse cutting direction from HG to TG. Assumption - 1minute.

6) Cutting first the bottom coal between two drums let in the 1st wedge cut in task 4(2nd wedge cut) and then full seam height coal cutting to the TG. Cutting length 20 m. Cutting speed based on the cutting resistance.

$$t_6 = \frac{20}{1,6} = 12,5 \text{ min};$$

7) Re-position of cowls and ranging arms to reverse cutting direction from TG to HG. Assumption - 1 minute.

8) AFC snaking length is approximately 20 m. Within this distance, the shearer cuts the bottom coal between the two drums and then runs empty from TG to the 424 m mark.

$$t_8 = \frac{20}{1,6} = 12,5 \text{ min};$$

9) Full speed coal cutting from TG to HG. Cutting length – 424 m. Cutting speed is constant.

$$t_9 = \frac{424}{1,6} = 265 \text{ min};$$

10) Re-position of cowls and ranging arms to reverse cutting direction from HG to TG. Assumption - 1 minute.

11) Cutting first the bottom coal between the two drums left in the TG to HG run of task 9(1st wedge cut) and then full seam height coal cutting to the 20 m mark. Cutting speed – 1,6 m/min.

$$t_{11} = \frac{20}{1,6} = 1,6 \text{ min};$$

12) Re-position of cowls and ranging arms to reverse cutting direction. Assumption - 1 minute.

13) Cutting first the bottom coal between the two drums left in the 1st wedge cut in task 11(2nd wedge cut) and then full seam height coal cutting to the HG. Cutting length – 20 m. Cutting speed – 8,68 m/min.

$$t_{13} = \frac{20}{1,6} = 1,6 \text{ min};$$

14) Re-position of cowls and ranging arms for reverse cutting direction and preparing for next cutting cycle. Assumption - 1 minute. After this, the winning machine is ready to mine next strip of the seam.

Total time for one cycle is a sum of time required for operations listed above.

$$\begin{aligned} \sum t &= t_1 + t_2 + t_3 + t_4 + t_5 + t_6 + t_7 + t_8 + t_9 + t_{10} + t_{11} + t_{12} + t_{13} + t_{14} \\ &= 12,5 + 265 + 1 + 12,5 + 1 + 12,5 + 1 + 12,5 + 12,5 + 1 + 12,5 + 1 + 12,5 \\ &\quad + 1 = 611 \text{ minutes.} \end{aligned}$$

The total time for one cycle is presumed – 611 minutes.

The factor of shearer utilization can be obtained from estimations, taking into account time for maneuvers and downtimes and maintenance operations. The factor of utilization is approximately 80%.

Production calculations

Total coal production per cutting cycle.

$$Q = m * B * l * 2 * \gamma = 3,15 * 1,15 * 444 * 2 * 1,35 = 4342,65 \frac{\text{tons}}{\text{cycle}};$$

where m – thickness of the seam;

B – web width, m;

l – panel width, m;

γ – in-situ density of coal, t/m^3 .

Average output per hour:

$$Q_h = Q * \frac{60}{\sum t} * k_f = 4342,65 * \frac{60}{611} * 0,8 = 341,16 \frac{t}{\text{hour}};$$

where k_f - factor of shearer utilization.

Output per shift:

$$Q_s = Q * 8 = 341,16 * 8 = 2729,26 \frac{t}{\text{shift}};$$

Output per day

$$Q_d = Q_s * 3 = 2729,26 * 3 = 8187,78 \frac{t}{\text{day}};$$

Output per week

$$Q_w = Q_s * 20 = 2729,26 * 20 = 54585,2 \frac{t}{\text{week}};$$

Annual output(raw coal)

$$Q_y = Q_w * 52 = 54585,2 * 52 = 2838430,4 \frac{t}{\text{year}};$$

where 52 – amount of weeks in the year.

In the seam is located a slice of the rock. Assuming the type of rock – limestone. The density of a limestone is from 2,5 to 2,7 t/m^3 . Based on this data, minimum ash content, which comes from the mining of the extracted coal may be calculated.

Amount of a hoist rock extracted from the seam:

$$Q_h = m_h * B * l * 2 * \gamma_h = 0,19 * 1,15 * 444 * 2 * 2,7 = 523,88 \frac{t}{cycle};$$

To determine ash content, the next equation is presented:

$$A = \frac{Q_h}{Q_t} = \frac{523,88}{4866,53} * 100\% = 10,8\%;$$

The total volume of rock mass, extracted per one cycle from the face of 444 m length:

$$Q_t = Q + Q_h = 4342,65 + 523,88 = 4866,53 \frac{t}{cycle};$$

So, in the end, the received product is going to be with a minimum 10,8 and 18,3% ash content.

To depict production rates for seams Fl. 970 and Fl. 950, the results are collected into a table.

Seam/Meaning	Thickness of a coal, m	Thickness of a limestone, m	Daily output, t/day	Ash content, %	Cycle time, min
Fl. 970	3,15	0,19	9175,5	10,8	611
Fl. 950	2,23	0,25	7096	18,3	611

Table 18. Daily output of the coal using bi-directional cutting sequence

9.2.2 Uni-di full-face cutting cycle

Cycle of operations

1) The shearer starts to move from the conjunction of HG and a face and mines the coal on the full web. On the side of TG, 16 m of the coal strip is already mined. The length of a run is: $444 - 16 = 428$ m. The speed of cutting is constant, taking into account on the factor of utilization, the speed of cutting – 1,6 m/min.

$$t_1 = \frac{428}{1,6} = 267,5 \text{ min};$$

2) Re-position of cowls and ranging arms to reverse cutting direction. Assuming 1 minute.

3) Extraction of the coal slice between the drums. The distance between drums – 16 m. So, the length of shearer movement – 16 m. Assuming maximum speed of cutting, which allows the cutting resistance – 1,6 m/min.

$$t_3 = \frac{16}{1,6} = 10 \text{ min};$$

4) "Empty" run of the shearer. The winning machine "cleans" a bottom from coal and loads it into AFC, what exclude a manual work in working face. The length of the run is: $444 - 16 - 16 = 414$ m. On a distance of 16 m to the HG speed of flitting will be changed. Cutting speed of "empty" flitting may be increased. To reduce the time of cycle, assume 27 m/min.

$$t_4 = \frac{412}{27} = 15,3 \text{ min};$$

5) Self-sumping of the shearer into a next coal strip. The distance of self-sumping – 15 m. The cutting speed – 1,6 m/min.

$$t_5 = \frac{16}{1,6} = 10 \text{ min};$$

6) Re-position of cowls and ranging arms to reverse cutting direction. Assuming 1 minute. After what, the shearer is ready to mine next strip of the coal.

Total time for one cycle is a sum of time required for operations listed above.

$$\sum t = t_1 + t_2 + t_3 + t_4 + t_5 + t_6 = 267,5 + 1 + 10 + 15,3 + 10 + 1 = 304,8 \text{ min};$$

The total time for one cycle is presumed – 305 minutes.

The factor of shearer utilization can be obtained from estimations, taking into account time for maneuvers and downtimes and maintenance operations. The factor of utilization is approximately 80%.

Production calculations

Total coal production per cutting cycle.

$$Q = m * B * l * \gamma = 3,15 * 1,15 * 444 * 1,35 = 2171,33 \frac{\text{tons}}{\text{cycle}};$$

where m – thickness of the seam;

B – web width, m;

l – panel width, m;

γ – in-situ density of coal, t/m^3 .

Average output per hour:

$$Q_h = Q * \frac{60}{\sum t} * k_f = 2171,33 * \frac{60}{305} * 0,8 = 341,7 \frac{t}{\text{hour}};$$

where k_f – factor of shearer utilization.

Output per shift:

$$Q_s = Q * 8 = 341,7 * 8 = 2733,7 \frac{t}{shift};$$

Output per day

$$Q_d = Q_s * 3 = 2733,7 * 3 = 8201,2 \frac{t}{day};$$

Output per week

$$Q_w = Q_s * 20 = 2733,7 * 20 = 54674 \frac{t}{week};$$

Annual output(raw coal)

$$Q_y = Q_w * 52 = 54674 * 52 = 2733700 \frac{t}{year};$$

In the seam is located a slice of the rock. Assuming the type of rock – limestone. The density of a limestone is from 2,5 to 2,7 t/m³. Based on this data, minimum ash content, which comes from the mining of the extracted coal may be calculated.

Amount of a hoist rock extracted from the seam:

$$Q_h = m_h * B * l * \gamma_h = 0,19 * 1,15 * 444 * 2,7 = 261,94 \frac{t}{cycle};$$

To determine ash content, the next equation is presented:

$$A = \frac{Q_h}{Q_t} = \frac{261,94}{2433,27} * 100\% = 10,8\%;$$

The total volume of rock mass, extracted per one cycle from the face of 444 m length:

$$Q_t = Q + Q_h = 2171,33 + 261,94 = 2433,27 \frac{t}{cycle};$$

So, in the end, the received product is going to be with a minimum 10,8 and 18,3% ash content.

To depict production rates for seams Fl. 970 and Fl. 950, the results are collected into a table. The haulage speed of the shearer will be the same on the seam Fl. 950, what will give the same time for cycle of cutting.

Seam/Meaning	Thickness of a coal, m	Thickness of a limestone, m	Daily output, t/day	Ash content, %	Cycle time, min
Fl. 970	3,15	0,19	9190,5	10,8	305
Fl. 950	2,23	0,25	7107,7	18,3	305

Table 19. Daily output of the coal using uni-di full-face cutting sequence

9.2.3 Uni-di half-face cutting cycle

Cycle of operations

1) The shearer starts to move from the conjunction of HG and a face. The shearer runs "empty" to the point splits the face to two equal parts. The length of the run is 222m. The speed of the shearer – 27m/min.:

$$t_1 = \frac{222}{27} = 8,3 \text{ min};$$

2) Self-sumping of the shearer and winning of the second half of the face with a speed of pull 1,6 m/min.

$$t_2 = \frac{222}{1,6} = 138,8 \text{ min};$$

3) Re-position of cowls and ranging arms to reverse cutting direction. Assuming 1 minute.

4) "Empty" run of the shearer. The winning machine "cleans" a bottom from coal and loads it into AFC, what exclude a manual work in working face. The length of the run is 222 m. The speed of movement – 27 m/min.

$$t_4 = \frac{222}{27} = 8,3 \text{ min};$$

5) Self-sumping of the shearer into a next coal strip. Extraction of the second part of the working face. Speed of pull 8,68 m/min.

$$t_5 = \frac{222}{1,6} = 138,8 \text{ min};$$

6) Re-position of cowls and ranging arms to reverse cutting direction. Assuming 1 minute. After what, the shearer is ready to mine next strip of the coal.

Total time for one cycle is a sum of time required for operations listed above.

$$\sum t = t_1 + t_2 + t_3 + t_4 + t_5 + t_6 = 8,3 + 138,8 + 1 + 8,3 + 138,8 + 1 = 296,2 \text{ min};$$

The total time for one cycle is presumed – 296 minutes.

The factor of shearer utilization can be obtained from estimations, taking into account time for maneuvers and downtimes and maintenance operations. The factor of utilization is approximately 80%.

Production calculations

Total coal production per cutting cycle.

$$Q = m * B * l * \gamma = 3,15 * 1,15 * 444 * 1,35 = 2171,33 \frac{\text{tons}}{\text{cycle}};$$

where m – thickness of the seam;

B – web width, m;

l – panel width, m;

γ – in-situ density of coal, t/m^3 .

Average output per hour:

$$Q_h = Q * \frac{60}{\sum t} * k_f = 2171,33 * \frac{60}{296} * 0,8 = 352,1 \frac{t}{\text{hour}};$$

where k_f - factor of shearer utilization.

Output per shift:

$$Q_s = Q * 8 = 352,1 * 8 = 2816,8 \frac{t}{\text{shift}};$$

Output per day

$$Q_d = Q_s * 3 = 2816,8 * 3 = 8450,5 \frac{t}{\text{day}};$$

Output per week

$$Q_w = Q_s * 20 = 2816,8 * 20 = 56336 \frac{t}{\text{week}};$$

Annual output(raw coal)

$$Q_y = Q_w * 52 = 56336 * 52 = 2929472 \frac{t}{\text{year}};$$

In the seam is located a slice of the rock. Assuming the type of rock – limestone. The density of a limestone is from 2,5 to 2,7 t/m^3 . Based on this data, minimum ash content, which comes from the mining of the extracted coal may be calculated.

Amount of a hoist rock extracted from the seam:

$$Q_h = m_h * B * l * 2 * \gamma_h = 0,19 * 1,15 * 444 * 2,7 = 261,9 \frac{t}{cycle};$$

To determine ash content, the next equation is presented:

$$A = \frac{Q_h}{Q} = \frac{261,9}{2433,23} * 100\% = 10,8\%;$$

The total volume of rock mass, extracted per one cycle from the face of 444 m length:

$$Q_t = Q + Q_h = 2171,33 + 261,9 = 2433,23 \frac{t}{cycle};$$

So, in the end, the received product is going to be with a minimum 10,8 and 18,3% ash content.

To depict production rates for seams Fl. 970 and Fl. 950, the results are collected into a table. The haulage speed of the shearer will be the same on the seam Fl. 950, what will give the same time for cycle of cutting.

Seam/Meaning	Thickness of a coal, m	Thickness of a limestone, m	Daily output, t/day	Ash content, %	Cycle time, min
Fl. 970	3,15	0,19	9470	10,8	296
Fl. 950	2,23	0,25	7323,8	18,3	296

Table 20. Daily output of the coal using uni-di half-face cutting sequence

Considering the results of the extraction with a usage various cutting sequences, the most productive is half-face uni-directional sequence. The biggest advantages of the system is that, the clearing operations of the left coal on a bottom of the face doesn't require additional manual work, because the shearer does it during the "empty" run; moving of the cowls is not so often in comparison with a bi-directional mining and self-sumping of the shearer doesn't requires additional split of the cycle.

9.2.4 Choose of cutting sequence

Considering the results of the extraction with a usage various cutting sequences, the most productive is half-face uni-directional sequence. The biggest advantages of the system is that, the clearing operations of the left coal on a bottom of the face doesn't require additional manual work, because the shearer does it during the "empty" run; moving of the cowls is not so often in comparison with a bi-directional mining and self-sumping of the shearer doesn't requires additional split of the cycle.

Based on the daily output, using this method and winning equipment, amount of the longwalls that work simultaneously, to achieve the goal of 30000 tons of usable material per day is:

for Fl. 970:

$$n_{l1} = \frac{30000}{9470} = 3,17 \approx 4.$$

for Fl. 950:

$$n_{l2} = \frac{30000}{7323,8} = 4,09 \approx 4.$$

The lack of production rate, during the mining seam Fl. 950 may be compensated, if its factor of shearer utilization will be applied at least 0,82, or, the shortage may be filled by production rate on the Fl. 970. Also, if the utilization factor of the shearer in time may be increased to 0,85, the only 3 working faces are needed to work simultaneously, to achieve the goal. If 4 longwalls will employ the uni-di half-face method for an extraction only the seam Fl. 970, the production from these faces will be as follow:

$$Q_4 = 9470 * 4 = 38827 \text{ t.}$$

The another one option, that working faces are located both on Fl. 970 and Fl. 950. Than the production rate will make up:

$$Q_{2-2} = 2 * (9470 + 7328,8) = 33587,65 \text{ t.}$$

9.2.5 Panel belt conveyor

The belt conveyor is used for moving the load from the AFC to incline belt conveyor. The calculations will be done according to the methodology given in the textbook by Bilichenko, 2002.

The initial data is:

- Productivity of the conveyor should be not less than:

$$Q_{970} = \frac{Q_{d,970}}{t_s * n_s} * 1,2 = \frac{9470}{8 * 3} * 1,2 = 473,5 \frac{\text{t}}{\text{h}};$$

where $Q_{d,970}$ production rate of the longwall were being mined from coal seams 970;

t_s - duration of the shift;

n_s - amount of shifts;

1,2 – assurance factor.

- angle of the gallery - 1°;
- length of a transportation – 1150 m.

For these conditions, the belt conveyor 2ЛТ80У-01 is suitable and it possesses certain technical characteristics. (see. Annex p. VI)

Calculations

1. Mass per 1 m:

of upper roller carriages:

$$q_u = \frac{m_{l,b}}{l_{l,b}} = \frac{14,7}{1,4} = 10,5 \frac{kg}{m};$$

of lower roller carriages:

$$q_l = \frac{m_{e,b}}{l_{e,b}} = \frac{11,62}{2,8} = 4,15 \frac{kg}{m};$$

of a load:

$$q_{l,970} = \frac{Q_{970}}{3,6 * V} = \frac{473,5}{3,6 * 2,5} = 52,61 \frac{kg}{m};$$

of a belt:

$$q_b = m_b * B = 17,6 * 0,8 = 14,08 \frac{kg}{m};$$

where $m_{l,b}$ and $m_{e,b}$ mass of rotating parts of roller carriage, loaded and empty respectively, kg;

$l_{l,b}$ and $l_{e,b}$ – distance between roller carriages, loaded and empty respectively, m;

m_b - mass of 1 m² of a belt, kg;

B - width of a belt, m;

V – velocity of a belt.

2. Driving force for the moving of branches:

lower(empty):

$$\begin{aligned} F_{1-2,970} &= L * q_b * g * (c_2 * \omega * \cos\beta - \sin\beta) + c_2 * q_l * g * \omega \\ &= 1150 * 14,08 * 9,81 * (1,1 * 0,04 * \cos 1 - \sin 1) + 1,1 * 4,15 * 9,81 * 0,07 \\ &= 4219,05 N; \end{aligned}$$

upper(loaded):

$$\begin{aligned} F_{4-3,970} &= L * g * (q_{l,970} + q_b) * (c_2 * \omega * \cos\beta + \sin\beta) + c_2 * L * q_u * g * \omega \\ &= 1150 * 9,81 * (52,61 + 14,08) * (1,1 * 0,07 * \cos 1 + \sin 1) + 1,1 * 1150 \\ &\quad * 10,5 * 9,81 * 0,07 = 80174,5 N; \end{aligned}$$

where g - gravitational force, m/s;

c_2 - factor, concerns local resistance to movements. For length of transportation more than 850 – 1,1.

ω – factor of branch movement resistance. For mine belt conveyors 0,06...0,08. Average value – 0,07 is applied.

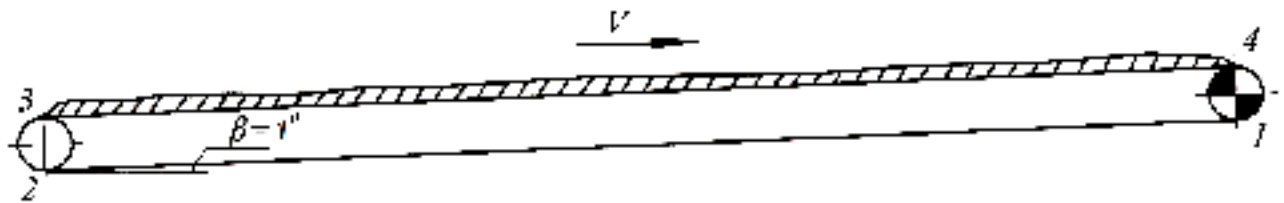

Figure 32. Scheme of the belt conveyor

3. Tractive power on driving drums:

$$F_{t.p.} = F_{1-2,970} + F_{4-3,970} = 4219,05 + 80174,5 = 84393,55 \text{ N};$$

4. Starting tension of the belt:

4.1 By the data of cohesion on the drive:

$$F_{coh.min} = \frac{F_{t.p.} * k_p}{e^{f\alpha} - 1} = \frac{84393,55 * 1,3}{2,85 - 1} = 59303,58 \text{ N};$$

where k_p - assurance factor of motor tractive ability, in range of 1,2...1,4. The average value of 1,3 is applied.

$e^{f\alpha}$ – factor of belt to drum cohesion, 2,85.

4.2 By the data of loaded branch deflection:

$$F_{Lmin} = (3000 \div 4000) * B = 3500 * 0,8 = 2800 \text{ N};$$

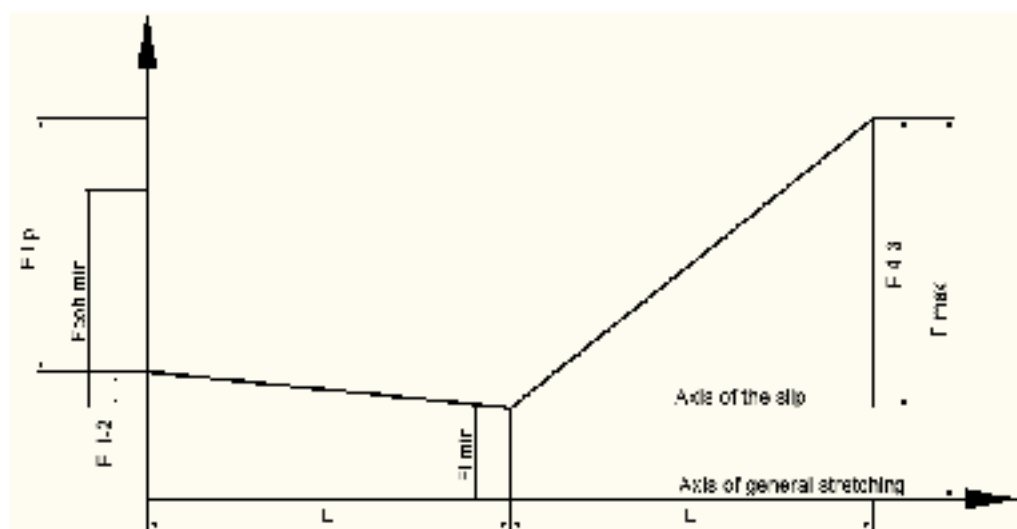

Figure 33. Diagram of belt tension

5. From the diagram, the maximum tension of the conveyor belt may be defined.

$$F_{max} = F_{4-3,970} + F_{l,min} = 80174,5 + 2800 = 82974,5 \text{ N};$$

6. Critical tension of the belt.

$$F_{crit} = 1000 * B * \sigma_t = 1000 * 0,8 * 9800 = 7,84 * 10^6 \text{ N};$$

where σ_t - breaking point of the belt.

7. Amount of conveyors for the given length of transportation.

$$n = \frac{F_{max} * m}{F_{crit}} = \frac{82974,5 * 10}{7,84 * 10^6} = 0,11 \approx 1;$$

For the transporting 1 conveyor belt is applied with a length of 1150 m.

8. Capacity of the drive motors of one conveyor.

$$N_{set} = \frac{F_{t.p.} * V * k_{reg}}{1000 * \varphi} = \frac{84393,55 * 2,5 * 1,1}{1000 * 0,93} = 249,55 \text{ kW};$$

where k_{reg} - regime factor, concerns irregularity of capacity distribution between drive motors.

φ - coefficient of efficiency.

Since sum drive motors capacity of the conveyor makes up 165 kW, two conveyors should be installed with an equal length of 575 m.

Additional check by capacity should be done.

$$N'_{set} = \frac{F'_{t.p.} * V * k_{reg}}{1000 * \varphi} = 124,77 \text{ kW};$$

where

$$F'_{t.p.} = \frac{F_{t.p.}}{n_{conv}} = \frac{84393,5}{2} = 42196,75 \text{ N};$$

Finally, to satisfy the requirements of conveyor capacity, 2 conveyors type 2BT80U-01 should be installed with a length of 575 m each.

9.3 Matching calculations for the shearer and AFC

Armored face conveyor should be appropriate for certain conditions of mining. Here, this condition is production rate of the one face. From the previous estimations, were defined that, the production volume of the face with a face length of 444 m is 292,2 m³/h from the coal seam Fl. 970 and 226 m³/h - Fl. 950. These values contain the volume of hoist rock as well.

Assuming, that additional load on the AFC will be required in amount of 10%. So, the amount of rock which is going to be load is – 321,5 and 248,6 m³/h.

Among the conveyors, which are proper for the shearer EL2000, conveyor with a pan width of 1032 mm may be applied. The minimum chain speed of the AFC, which will be satisfied for the production rate can be estimated. (cp. Peng, 2006)

$$V_c = \frac{Q_r}{W_p * C_c * s} * \frac{m}{h};$$

where Q_r - amount of rock which is going to be load, m³/h;

W_p - width of the pan, m;

C_c - clearance on the side, from the AFC toeplate to the drum, m;

s – swelling factor, 1,3.

Due to the production rates, the speed of the chain will be various during the extraction of the different seams.

Seam/Meaning	Thickness of the seam, m	Assumed amount of the rock, m ³ /h	Chain speed, m/min
Fl. 970	3,34	321,5	14,4
Fl. 950	2,48	248,6	11,4

Table 21. Chain speed of the AFC CAT PF4/1032

So, the speed of chains of the AFC with a pan width of 1032 mm should be 14,4 and 11,4 m/min.

In the same time, when shearer cuts from head to tail, coal is cut by the tail drum has to pass under it. In this case, the clearance under the shearer is a crucial factor. The following calculations are intended to check it.

1. Headgate to tailgate cutting trip. Volume of the coal that passes below the shearer, which is cut by the front drum depends on the drum cutting speed.

$$Q_c = B * D * V_d * \frac{m^3}{min};$$

where B – cutting width, 1,15 m;

D – drum diameter, 1,9 m;

V_d – shearer's haulage speed, m/min. The haulage speed during the uni-di half-web cutting sequence is 1,6 m/min for the both seams.

So, for in-situ volume:

$$Q_c = 1,15 * 1,9 * 1,6 = 3,5 \frac{m^3}{min};$$

and broken volume:

$$Q_c = 1,15 * 1,9 * 1,6 * 1,3 = 4,54 \frac{m^3}{min};$$

where 1,3 – swelling factor.

The clearance area under the shearer is approximately 0,67 m². It can be obtained, if the pan width is the minimum – 1032 mm, what is appropriate for the chosen shearer, is multiplied to clearance under the shearer, 649 mm. Assuming, the coal travels at the same speed as conveyor, the volume per unit time passing under the shearer is:

$$Q_u = C * V_c, \frac{m}{min};$$

where C – area under the shearer, m²;

V_c – chain speed, m/min.

So, for the AFC installed in the face of Fl. 970:

$$Q_{u1} = 0,67 * 14,4 = 9,65 \frac{m}{min};$$

and in the face of Fl. 950:

$$Q_{u2} = 0,67 * 11,4 = 7,64 \frac{m}{min};$$

Result. The volume of the coal which is cut by the shearer's front drum has to pass below the shearer and should match the carrying capacity of the conveyor. Comparing the Q_c and Q_{u1} and Q_{u2} , the carrying capacity of the conveyor under the shearer is much higher than the coal cut by the front drum of the shearer. The conclusion is, that the shearer can be run with a haulage speed of 1,6 m/min.

2. Tailgate to headgate cutting trip. Cut by both drums.

$$Q_{t.c.} = B * m * V_d, \frac{m^3}{min};$$

where m – thickness of the seam, m.

So, for the Fl. 970 coal seam:

for in-situ volume:

$$Q_{t.c.} = 1,15 * 3,34 * 1,6 = 6,14 \frac{m^3}{min};$$

and broken volume:

$$Q_{t.c.} = 1,15 * 3,34 * 1,6 * 1,3 = 7,98 \frac{m^3}{min};$$

and for the Fl. 950 coal seam:

for in-situ volume:

$$Q_{t.c.} = 1,15 * 2,48 * 1,6 = 4,56 \frac{m^3}{min};$$

and broken volume:

$$Q_{t.c.} = 1,15 * 2,48 * 1,6 * 1,3 = 5,93 \frac{m^3}{min};$$

Result. Comparing the estimations above, the total carrying capacity of the conveyor is enough high to satisfy the conditions of coal cutting by the shearer when it travels with a constant speed on the both coal seams. The haulage speeds are the same on the coal seams Fl.970 and Fl. 950.

According to Peng, 2006, the following conditions, in the choice of the AFC must be satisfied:

if $2D > H$

a. Cutting from tailgate to headgate

for the Fl. 970:

$$\begin{aligned} (D * s * V_s * S_f) + ((H - D) * s * V_s * S_f) &\leq \text{full haulage carrying capacity} \\ (1,9 * 1,15 * 1,6 * 1,3) + ((3,34 - 1,9) * 1,15 * 1,6 * 1,3) &\leq 43,34 \\ 7,98 &\leq 7,98 \end{aligned}$$

for the Fl. 950:

$$\begin{aligned} (D * s * V_s * S_f) + ((H - D) * s * V_s * S_f) &\leq \text{full haulage carrying capacity} \\ (1,9 * 1,15 * 1,6 * 1,3) + ((2,48 - 1,9) * 1,15 * 1,6 * 1,3) &\leq 43,34 \\ 5,93 &\leq 5,93 \end{aligned}$$

The condition is met.

b. Cutting from headgate to tailgate

$$(S_f * D * s * V_s) \leq \text{haulage carrying capacity under the shearer}$$

$$(1,3 * 1,9 * 1,15 * 1,6) \leq 46,88$$

$$4,54 \leq 4,54$$

The condition is met.

The armored face conveyor PF4/1032 is suitable for the given conditions.

9.4 Reserves estimation

Total volume of the reserves in the mine field, may be assessed based on the dimensions of given coal seams and their thicknesses. With a data of total volume, a conclusion about approximate lifetime of the mine can be done. Assuming, the coal seams has a proper rectangular shape. Therefore, the next equations could be made:

$$\sum Z_{970} = m_{970} * (S_{1,970} + S_{2,970} + S_{3,970} + S_{4,970} + S_{5,970} + S_{6,970} + S_{7,970} + S_{8,970}), m^3;$$

$$\sum Z_{950} = m_{950} * (S_{1,950} + S_{2,950} + S_{3,950} + S_{4,950} + S_{5,950} + S_{6,950} + S_{7,950} + S_{8,950}), m^3;$$

where $S_{n,m}$ – area of a seam "m" in a bed series "n", m^2 .

It should be noticed, that these numbers give a definition of total volume of coal in the mine field, and not that which can be mined feasible.

1) Reserves in the seam Fl. 970

volume of coal share in the seam Fl. 970

$$\begin{aligned} \sum Z_{970} &= 3,15 * 14050 * (1137 + 876 + 852 + 613 + 1089 + 330 + 1134 + 2945) \\ &= 397255320 m^3; \end{aligned}$$

volume of limestone share in the seam Fl. 970

$$\begin{aligned} \sum Z_{970} &= 0,19 * 14050 * (1137 + 876 + 852 + 613 + 1089 + 330 + 1134 + 2945) \\ &= 23961432 m^3; \end{aligned}$$

what gives a total volume in tonnage in the seam Fl. 970:

$$\sum Z_{970}^t = 397255320 * 1,35 + 23961432 * 2,7 = 600990548,4 t.$$

2) Reserves in the seam Fl. 950

volume of coal share in the seam Fl. 970

$$\begin{aligned}\sum Z_{950} &= 2,23 \cdot 13930 \cdot (1184 + 758 + 994 + 663 + 969 + 330 + 1134 + 3040) \\ &= 281811700,8 \text{ m}^3;\end{aligned}$$

volume of limestone share in the seam Fl. 970

$$\begin{aligned}\sum Z_{950} &= 0,25 \cdot 13930 \cdot (1184 + 758 + 994 + 663 + 969 + 330 + 1134 + 3040) \\ &= 31593240 \text{ m}^3;\end{aligned}$$

what gives a total volume in tonnage:

$$\sum Z_{950}^t = 281811700,8 \cdot 1,35 + 31593240 \cdot 2,7 = 465747544,08 \text{ t.}$$

In the conditions, which were presented before, such a width of the face, cutting sequence, appropriate winning machines, the more beneficial is the mining of seams with a uni-directional half-face cutting sequence, using the CAT EL2000 shearer loader.

Without including losses of the coal during the mining, the coal which will be mined during the drifting, and the pillars which are not feasible to mine, the whole coal could be mined during the period of:

$$T = \frac{\text{Total volume of minerals in coal seams}}{\text{Annual production capacity}}, \text{ year};$$

In case of employing 4 working faces separately on two seams, e.g. the only one coal seam is under extraction in certain period of time:

$$T = \frac{600990548,4}{9470 \cdot 4 \cdot 360} + \frac{465747544,08}{7323,8 \cdot 4 \cdot 360} = 44,07 + 44,16 = 88,23 \text{ years};$$

Bed series 4 and 7, are contained in coal seams Fl. 970 and Fl. 950, have a relatively short lengths to be extracted with the longwall mining method, accordingly to experience of USA and Australian coal mining. On this purpose, they might be extracted with a room-and-pillar method.

So, the coal, taking to account unmineable bed series 4 and 7, could be mined in period of:

$$\begin{aligned}T &= \frac{600990548,4 - 63138824,3}{9470 \cdot 4 \cdot 360} + \frac{465747544,08 - 50979641,8}{7323,8 \cdot 4 \cdot 360} = 39,44 + 39,32 \\ &= 78,76 \text{ years};\end{aligned}$$

10 Conclusion

This graduate work focused on achieving a daily production target of coal in 30000 tons of usable material out of two coal seams. Under a consideration of certain parameters, namely, angles of the dip and strike, seam's thickness, depth of the bed, a location of a mine allotment, a structure and characteristics of the deposit, it was decided to develop the field by a method of the longwall mining.

Options for an opening of the mine field were regarded and an advantage took a method of the opening by 3 vertical shafts. One of the shafts, upcast and transport shaft, locates in a middle of the mine field, when 2 other shafts are downcast and intended for air supply for each half of the mine field.

The direction of winning operations conducted to a centre of the mine allotment, starting from edges with a full collapsing of a goaf with an advance of the working face and with a decrease of a length of preparation workings after a panel was mined.

The development of the panels was done taking into account examples of longwall panel design by leading countries in coal mining by an underground longwall method such as Australia, U.S.A and Germany. Different types of an entry system and principles of a barrier pillar design were considered. As a result, it was decided to apply two-entry system for a preparation of the panels and among several approaches of barrier pillar design, the average value were implemented.

Highly mechanized equipment provided by leading companies in a construction of mining equipment such a CAT, Joy and Eickhoff were considered in this work. Among these companies shearer loaders for given conditions were selected and checked. After an estimation of their production capability, the preference remains for the SL CAT EL2000.

For a transportation of coal from the working space, a scraper conveyor PF4/1032 CAT company's was chosen. The selection was made based on the reception capacity of the pipeline and ability to co-work with the mentioned SL.

Considering a support of the space in the extraction area, based on the pressure of a destroyed crack rock above the face, and an experience of using an identical type of shields, it was decided to use MS Joy Group A and B, for coal seams Fl. 970 and Fl. 950 respectively.

Moving the coal from along a headgate is provided by a belt conveyor 2ЛТ80-У. Another conveyor belt with similar technical characteristics may be also employed.

According to the results of performance of the winning machine, as a result, to ensure the planned production rate of the mine of 30000 tons of usable material, it is required a simultaneous extraction of the coal from 4 working faces with parameters given in this thesis. Time for the mining whole volume of coal makes up 78,76 years, if 4

panels are being mined from one coal seam, and 88,23 – from two coal seams, 2 panels from each one.

Bibliography

1. Peng, Syd (2006) Longwall Mining, 2nd Ed.: Department of Mining Engineering West Virginia University, Morgantown, ISBN 97809789938307.
2. Bondarenko V. I., Kuzmenko A.M., Gryadushii Y.B., Kolokolov O.V., Kharchenko V.V., Tabachenko N.M., Pochevov V.N.: Technology of an underground mining of the seam deposits: Textbook for a high school – Dnipropetrovsk, 2002. – 730 p.
3. Majdi, A., Hassani, F.P. and Cain, P.: Two new barrier pillar design methods for longwall mining, Min. Sci. Technol., 13 – Amsterdam, 1991. – 323-336 p.
4. Kharchenko V.V., Ovchinnikov N.P., Sulaev V.I., Gaidai A.A., Russkich V.V.: Stopping processes in coal mines' seams: Textbook – Ministry of an Education and Science of Ukraine, Nat. min. univ. – M.:NMU, 2014 – 170 p., ISBN 9789663504995.
5. Agapito Associates, Inc. Grand Junction, Colorado, J.F.T. Agapito, Ph.D., P.E. Leo J. Gillbride, P.E.: Two-entry yield pillar gateroad systems in Western U.S. Longwall Mines: Presentation – MSHA Belt Air Technical Study Committee. - Salt Lake City, Utah – May 17, 2007.
6. Mitchell, G.W.: Longwall Mining: Monograph 12 – Australasian Coal Mining Practice., Chapter 15 – 2009.
7. Runge Pincock Minarco: Selecting a longwall panel – An objective approach: Magazine – Issue No. 126 – December 2014.
8. Vasyuchkov Y. F.: Mining: Textbook. – M.Nedra, 1990. – 512 p. ISBN 5247004752.
9. Annual Coal Report 2014 – U.S. Energy Information Administration, Independent Statistics & Analysis: Report – Washington, DC 20585.
9. C. Reichl, M. Schatz, G. Zsak. International Organizing Committee for the World Mining Congresses: World Mining Data. Minerals Production: Report , Volume 31 – Vienna, 2016.
10. DIX, KEITH. "Front Matter." What's a Coal Miner to Do?: The Mechanization of Coal Mining. U of Pittsburgh, 1988. I-IV. Web.
11. Mischo H.: Technology underground mining – Hard coal mining: Presentation – Freiberg – WS 2015/2016.
12. Walter T.: Closing down the mining in the Saar region Germany: Are we creating a transboundary "great man-made aquifer"?: Presentation – International workshop on groundwater systems in Europe, Berlin – August 22-23, 2013.
13. Fetzer K.D., Enright E., Grenzius R., Kubiniok J., Schwartz C., Morel J-L.: Garden soils in south-western Germany(Saarland) north-eastern France(Lorraine): Scientific paper – Saarbrücken, Germany.
14. Caterpillar: Caterpillar Performance Handbook: Operation and Maintenance manual – Peoria, Illinois, U.S.A. – January 2015.
15. Joy Global: Longwall systems: Product overview – Joy Global Inc.
16. Fiscor Steve: U.S. Longwall operators scale back production: CoalAge – February, 2014.
17. Eickhoff Bergbautechnik GmbH: SL750 Shearer Loader: Brochure – Germany.

18. Peisakhovich G.Y.: Mining transport technique: Vol. 3 Underground belt conveyors: Handbook – Moscow – 1990.
19. Bilichenko M.Y.: Basics of theory and calculations of mechanization of transport facilities for materials movement: Textbook – National mining university – Dnipropetrovsk – 2002.

List of figures

Figure 1. Coal production worldwide	16
Figure 2. Steam coal production in 2014.....	16
Figure 3. Coking coal production in 2014	17
Figure 4. Lignite production in 2014	17
Figure 5. Shafts in the coal production region	18
Figure 6. Ibbenbüren mine	19
Figure 7. Prosper-Haniel mine.....	19
Figure 8. Changes of production and labour force in Saar mine	20
Figure 9. Boundaries of a mine allotment.....	21
Figure 10. Position of coal seams in the strata.....	21
Figure 11. 3D model of the coal seams.....	22
Figure 12. Corrected boundaries of the mine allotment №1	23
Figure 13. Corrected boundaries of the mine allotment №2.....	24
Figure 14. Geology and hydrogeology of the Saar region	26
Figure 15. Protective areas inside the mine allotment.....	27
Figure 16. Dependency of a recovery rate from a panel width	34
Figure 17. Layout of the panel.....	35
Figure 18. Entry systems.....	36
Figure 19. Bi-di cutting sequence	40
Figure 20. Uni-di backward snake cutting sequence	41
Figure 21. Uni-di half-face cutting ssequence	41
Figure 22. Longwall advance mining	42
Figure 23. Retreat longwall mining	43
Figure 24. Layout of the shearer loader Eickhoff SI750.....	46
Figure 25. Visual look of the shearer loader Eickhoff SI750	46
Figure 26. Layout of the shearer loader Joy 7LS2A	47
Figure 27. Haulage pull and speed of the machine	49
Figure 28. Front view of the shearer loader CAT EL2000	50
Figure 29. Side view of the shearer loader CAT EL2000	51
Figure 30. Layout of the AFC CAT PF4/1032.....	52
Figure 31. Capacity of the AFC CAT PF4/1032.....	52

Figure 32. Scheme of the belt conveyor	70
Figure 33. Diagram of belt tension	70
Figure 34. Group A Joy mechanized roof support.....	87
Figure 35. Group B Joy mechanized roof support.....	88
Figure 36. Panels in the coal seam Fl. 970	89

List of tables

Table 1. Coordinates of a mine allotment.....	20
Table 2. Corrected coordinates of the mine allotment №1	22
Table 3. Corrected coordinates of the mine allotment №2	24
Table 4. Characteristics of the mine field	24
Table 5. Characteristics of the workable coal seams	25
Table 6. Width of a barrier pillar	38
Table 7. Main characteristics of the shearer loader Eickhoff SI750	45
Table 8. The main characteristics of the shearer loader Joy 7LS2A	48
Table 9. Characteristics of the arms for the shearer loader Joy 7LS2A	48
Table 10. The main characteristics of the shearer loader CAT EL2000	49
Table 11. Characteristics of the haulage unit for the SL CAT EL2000	49
Table 12. Front dimensions of the shearer loader CAT EL2000.....	50
Table 13. Side dimensions of the shearer loader CAT EL2000.....	51
Table 14. The main characteristics of the AFC CAT PF4/1032.....	51
Table 15. The main dimensions of the AFC CAT PF4/1032.....	52
Table 16. The main characteristics of the mechanized roof supports.....	53
Table 17. Theoretical performance of the winning machines	56
Table 18. Daily output of the coal using bi-directional cutting sequence	62
Table 19. Daily output of the coal using uni-di full-face cutting sequence	65
Table 20. Daily output of the coal using uni-di half-face cutting sequence	67
Table 21. Chain speed of the AFC CAT PF4/1032.....	72
Table 22. Dimensional characteristics of the coal seams.....	85
Table 23. Areas of usage the shearer loader Joy 7LS2A.....	86
Table 24. Characteristics of the belt conveyor 2ЛТ80У-01.....	90

List of abbreviations

AFC	Armored Face Conveyor
SL	Shearer Loader
MS	Mechanized support

Annex

Panel design

Coal seam	Bed series	Length on the strike, m	Length on the dip, m		Angle of the strike, degree
			18°	25°	
Fl. 970	1	1137	5392	8658	-4
	2	876			+190
	3	852			+190
	4	613			+190
	5	1089			+190
	6	330			+190
	7	1134			+190
	8	2945			+180
Fl. 950	1	1184	5272	8658	-4
	2	758			+190
	3	994			+190
	4	663			+190
	5	969			+190
	6	330			+190
	7	1134			+190
	8	3040			+180
Fl 930	1	1232	5152	8658	-4
	2	568			+190
	3	1088			+190
	4	710			+190
	5	755			+190
	6	330			+190
	7	1134			+190
	8	3150			+180

Table 22. Dimensional characteristics of the coal seams

Shearer loader Joy 7LS2A

Mine	Seam height, m	Cutting height, m	Panel width, m	Panel length, m	Overburden, m
Mach Mining	1,8	2,1	427	7925	152
Sugar Camp A	1,8	1,8	427	5791	274
Sugar Camp B	1,8	2,1	427	5944	274
Bailey	1,6-1,8	2,4	457	3658	183-305
Cumberland	2-2,1	2-2,1	482	3658	183-366
Emerald No. 1	1,8-2,1	1,8-2,1	381-442	3048	152-305
	1,8-2,1	1,8-2,1	442	1219	152-305
Enlow Fork	1,6-1,8	2,3	457	7925	183-305
	1,6-1,8	2,2	457	7925	183-305
Harrison Country	2,3	2,2	427	3658	274
Leer	2,4	2,1	366	2743	229
Mountainer II	2,1	2,1	305	1524	335

Table 23. Areas of usage the shearer loader Joy 7LS2A

Mechanized support

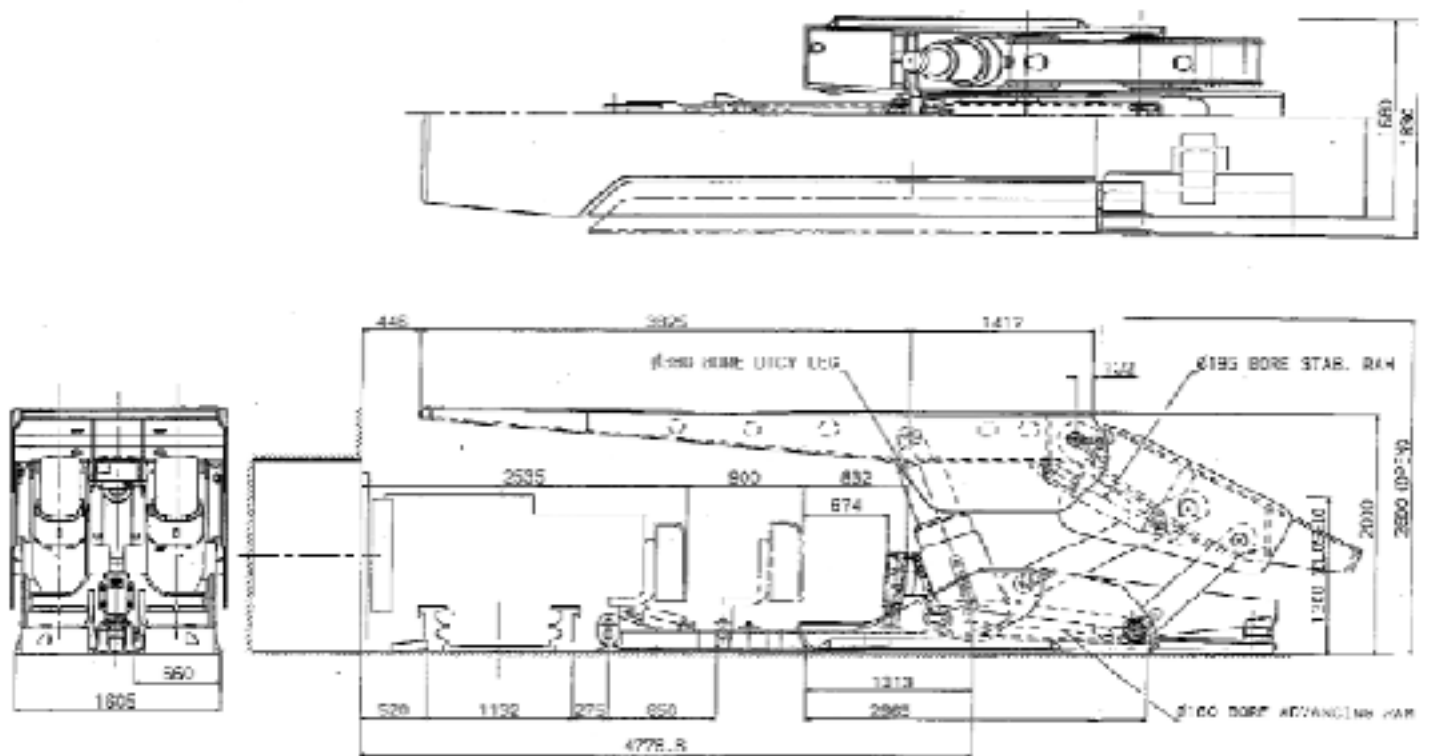

Figure 34. Group A Joy mechanized roof support

Panel design

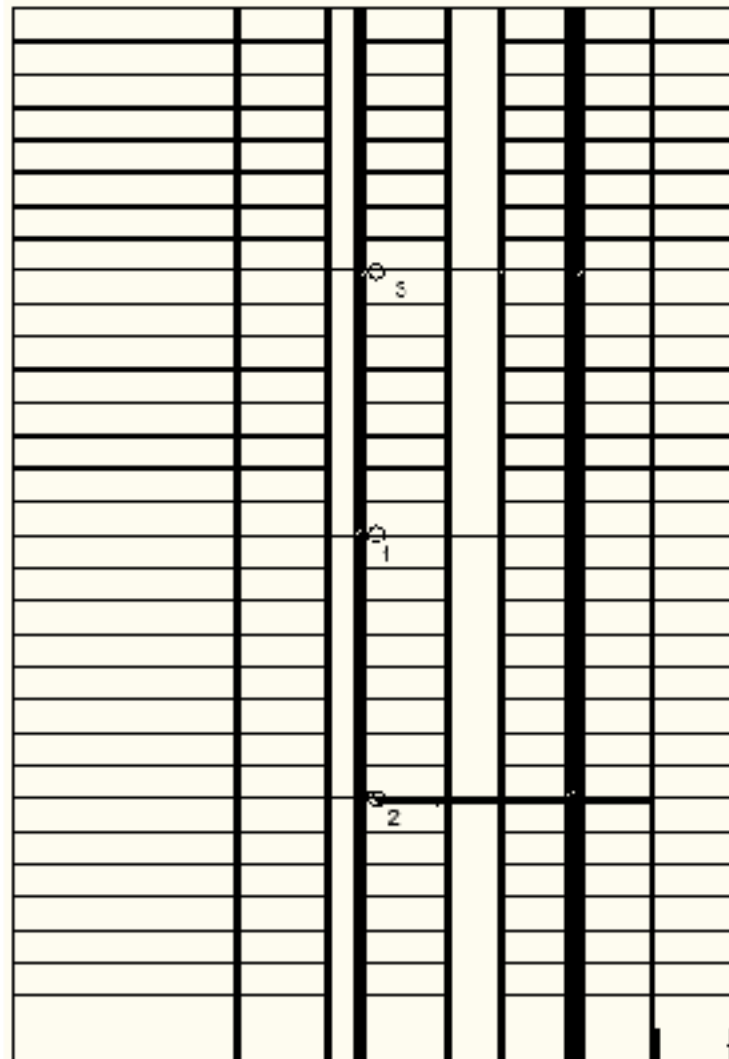

Figure 36. Panels in the coal seam Fl. 970

Panel belt conveyor

Characteristic	Meaning	
Velocity of the belt, m/s	2,5	
Maximum capacity, t/h	520	
Receiving capacity, m ³ /min	10,2	
Total power of drive, kW	55x3	
Belt type	2Шx800x4xTK	
Length of the one conveyor, m	600	
Amount of drive drums	3	
Contact angle of drive drums, degree	240	
Type of motors	ЭДКОФ43 - 4	
Hydraulic clutch	ГПЭ - 400	
Diameters of the drive drums, mm	500	
Diameter of an idler, mm	89	
Mass of rotating parts of roller carriage, kg	Loaded branch	Empty branch
	14,7	11,62
Distance between roller carriages, mm	1400	2800
Mass of 1m ² of a belt, kg	17,6	

Table 24. Characteristics of the belt conveyor 2BT80U-01